

LOTUS ENGINEERING

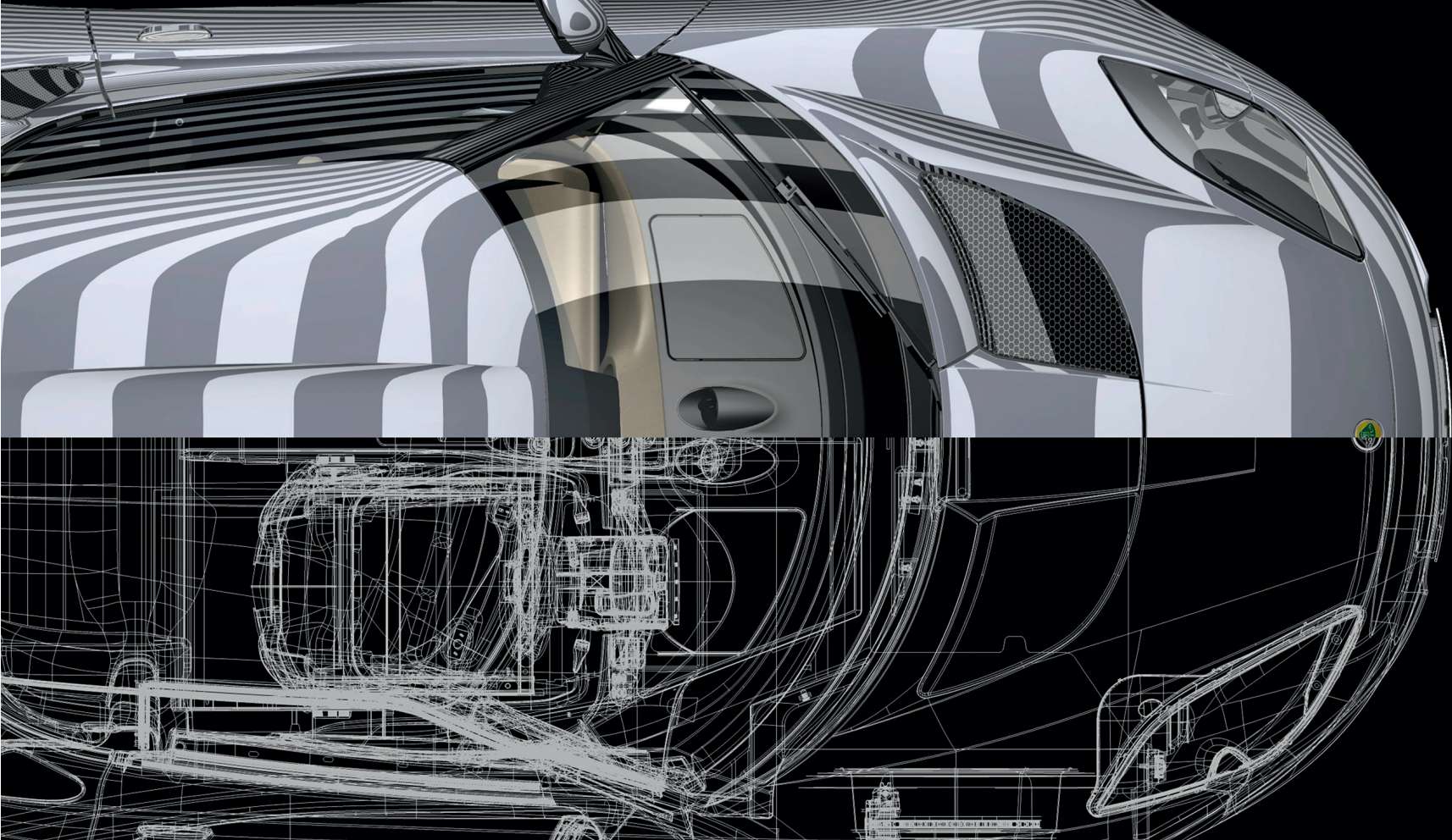

CONTENTS

Lotus Engineering – unique in the industry	2-3	Electrical and Electronic Integration	34-35
The Chapman legacy	4-5	Hybrid and electric vehicles – charging ahead	36-37
The Lotus heritage	6-7	In full control	38-39
A different perspective	8-9	Man and machine	40-41
Focused on excellence	10-11	Driving Dynamics	42-43
Lotus is global	12-13	In the driving seat	44-45
Efficiency, sustainability and enjoyment	14-15	An art and a science	46-47
Leaders in our field	16-17	Sound engineering	48-49
Lightweight Architectures	18-19	A world-class combination	50-51
Bespoke platforms for the client	20-21	Full programmes – the total package	52-53
Proven platforms for success	22-23	Future thinking	54-55
Lightweight is the right weight	24-25	In pursuit of knowledge	56-57
Efficient Performance	26-27	Helping in different ways	58-59
Fresh ideas, cleaner engines	28-29	Close to our clients	60-61
Upgrades and new applications	30-31	Lotus Engineering – driving innovation	62-63
Alternative fuels – pure performance	32-33	Contact us	64

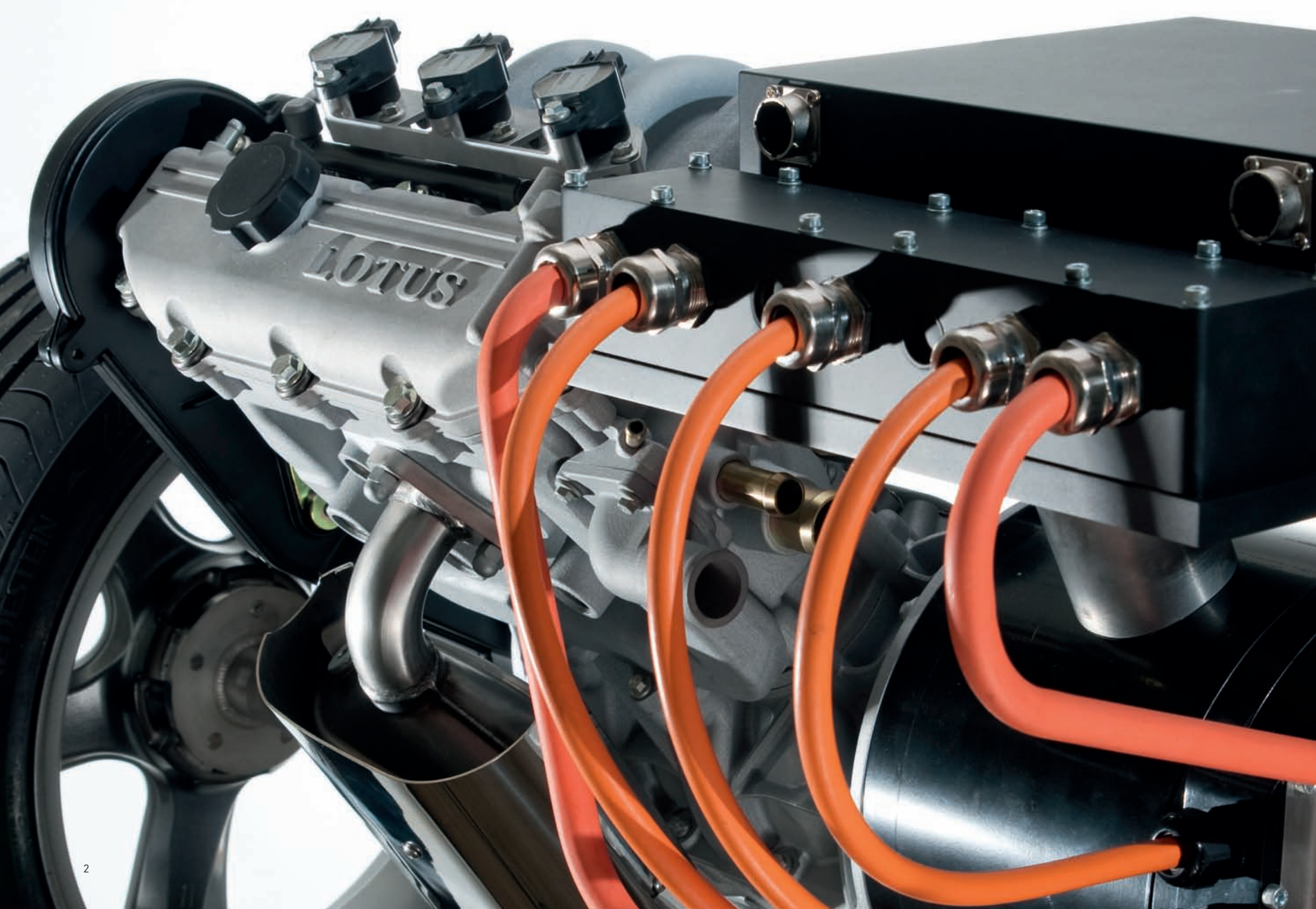

LOTUS ENGINEERING – UNIQUE IN THE INDUSTRY



Lotus Engineering is unique, offering a blend of technical excellence, passion and performance that is unrivalled in the automotive industry.

We have a proven track record taken from almost 60 years' experience in motor racing, producing our own cars and working for hundreds of clients in the automotive industry and beyond. Engineering excellence, innovation and design flair is instilled into everything we do, from powertrain and chassis design, driving dynamics, electrical and electronic integration, through to production and final manufacture.

Lotus Engineering can focus on the design and development of a single component, or employ the full capability of our engineering specialisms to take concepts through to the final completion of your product. Only we can do this, because we are the only engineering consultancy that designs and manufactures our own cars – and each is proof of our quest for perfection.

We have a client base that spans the globe from Europe, America, Japan and Asia, and have the proven ability, knowledge and expertise to make your projects succeed.

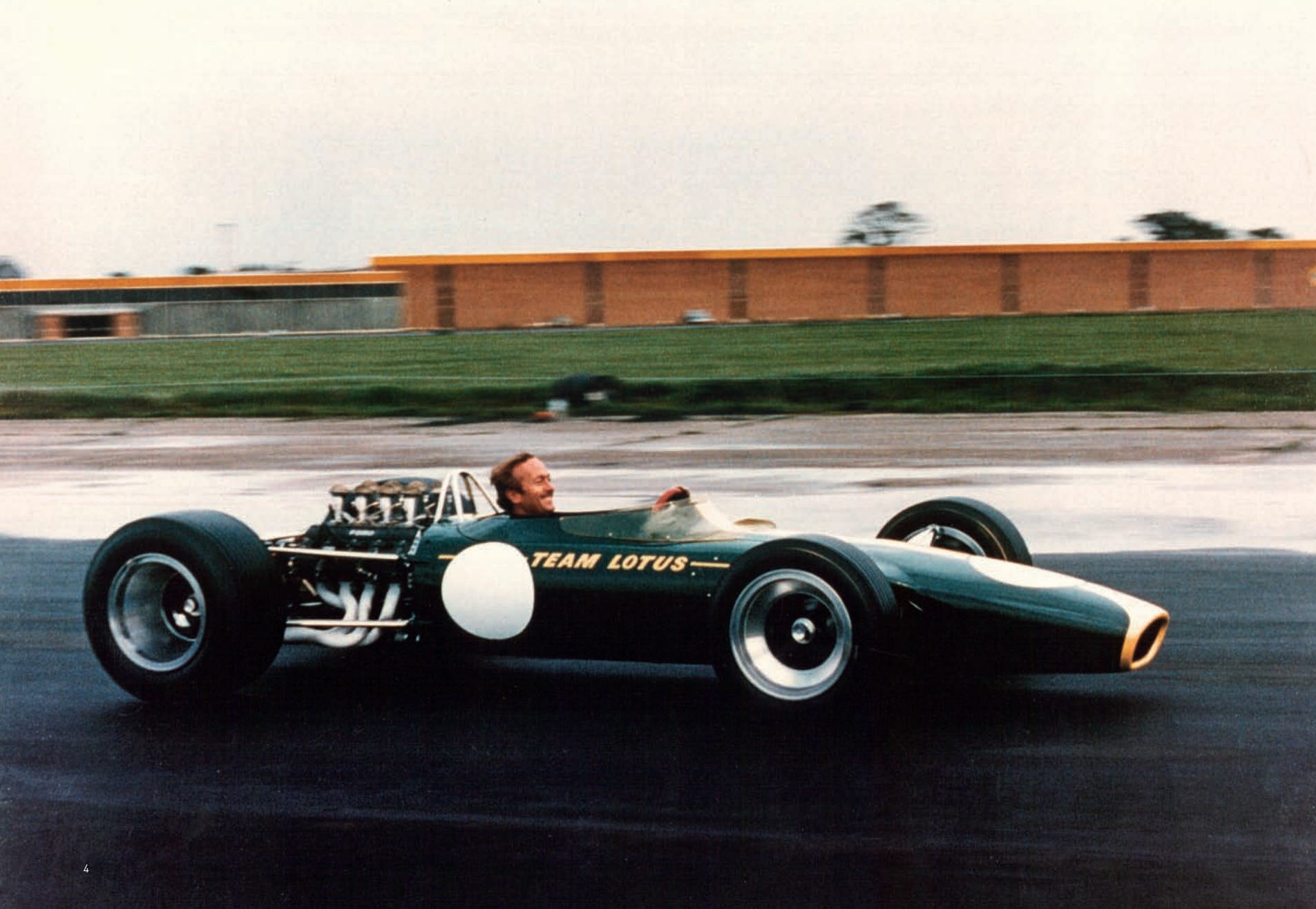



THE CHAPMAN LEGACY

Colin Chapman built his first car – the Mark 1 – in 1948 and founded the Lotus Engineering Company in 1952. Many other cars soon followed, including the seminal Lotus 7 of 1957, the essence of which still forms the basis of many lightweight, dynamic-handling sports cars today.

Since then, Lotus has created some of the world's most iconic sports cars; each and every one has reflected his philosophy of performance through light weight.

On track, Lotus has a rich history across many four-wheeled disciplines, while in Formula 1 has competed in more than 475 Grand Prix, with 79 victories, seven manufacturers' championships and six drivers' championships.

Chapman died in 1982, but his thinking has been the bedrock of all of our successes – on road and track – and we continue to reflect his relentless passion and innovation.

We believe the ideals he represented are more important and relevant in today's global automotive industry than ever before. It is his legacy to us and it is embedded in everything we do here at Lotus Engineering.



THE LOTUS HERITAGE

Lotus has a fine heritage of building exciting, desirable cars, such as the Esprit, Elan, Elise, the Exige and now the Evora. We bring together our world-renowned engineering expertise to create cars with a unique character that communicate with the driver and, above all, are fun to drive.

Our skills are not just reserved for sports cars.

We can apply the lessons we have learned from the last 60 years of engineering to any conventional car for our clients.

And this is where our sensitivity to brand and character helps – because we live by it with every car that carries our badge and the initials of our founder, Anthony Colin Bruce Chapman.

From creating the template for the modern Formula 1 car to spearheading 4-valve technology, from pioneering active suspension to bringing bonded aluminium structures to vehicle production, Lotus has thrust breakthrough after breakthrough into the automotive arena.



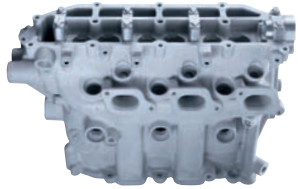

A DIFFERENT PERSPECTIVE

Lotus Engineering has a clear advantage; not only do we design and develop engineering solutions, we also manufacture and sell our own cars to very enthusiastic customers – worldwide.

All Lotus cars embody our engineering ethos: to produce enthralling vehicles notable for their excellent driving dynamics and efficient performance. It is the purity of the Lotus driving experience which captivates our customers and inspires the press to shower accolades on our cars.

So, whether the client needs us to create an intelligent body structure that is both lightweight and rigid, use our development expertise to improve the performance and efficiency of a mass-produced engine, or combine all of our engineering competencies into a complete product design, we are able to assist and understand the need from the perspective of a vehicle manufacturer.



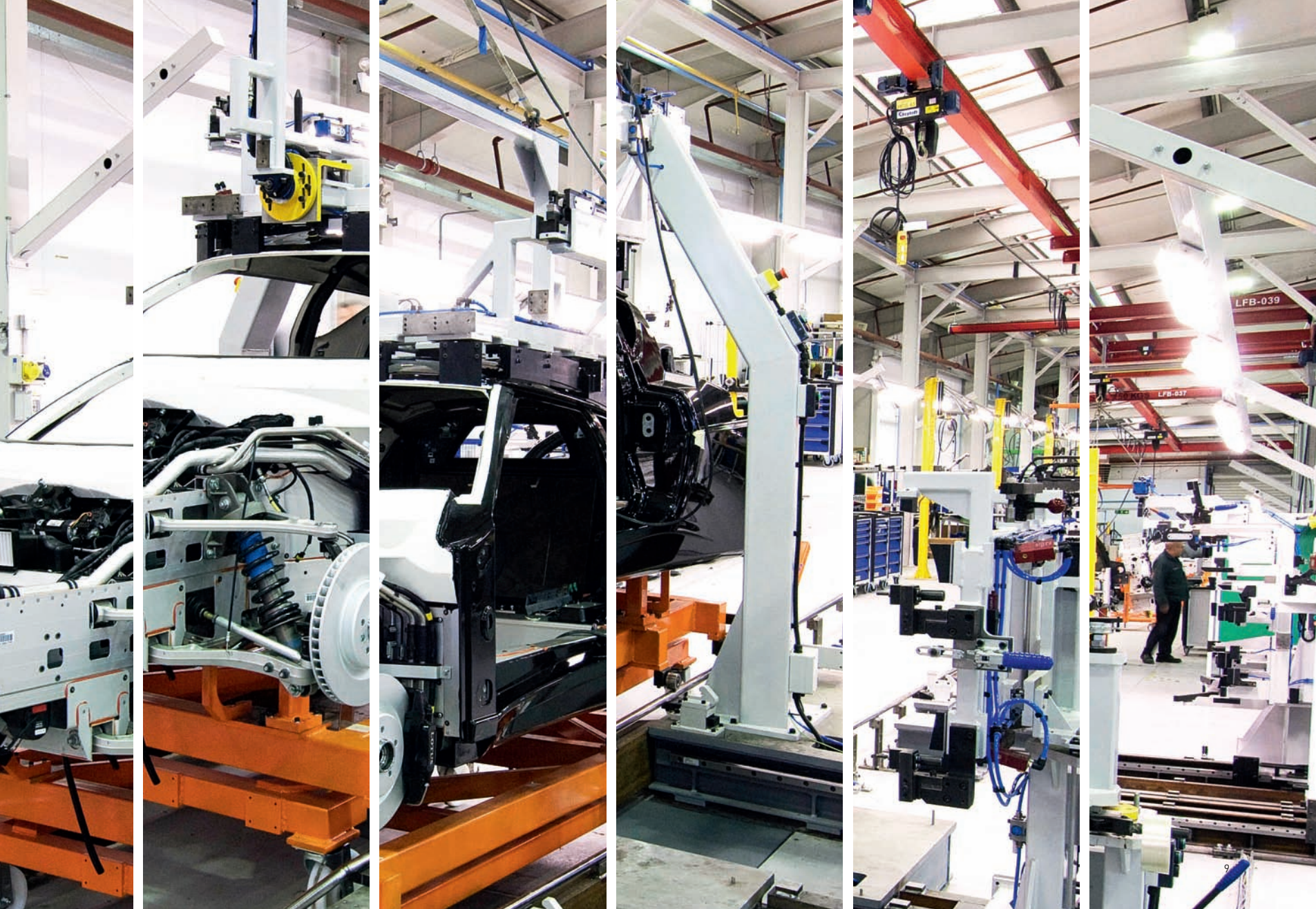

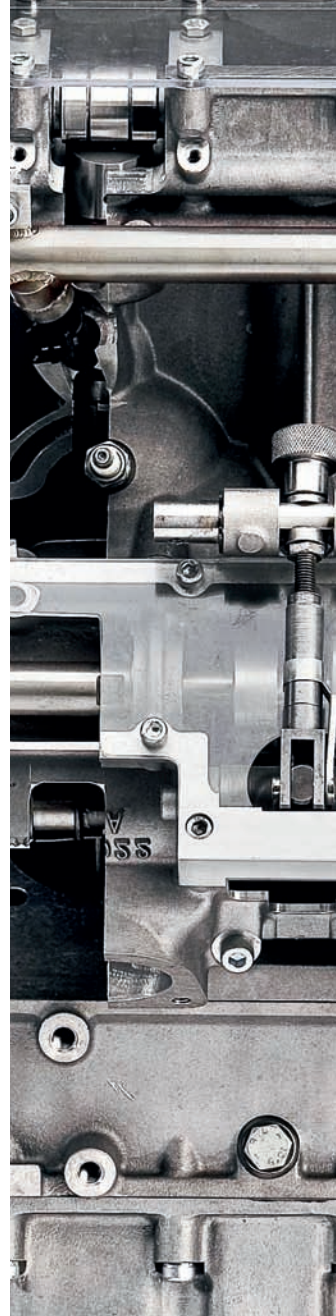
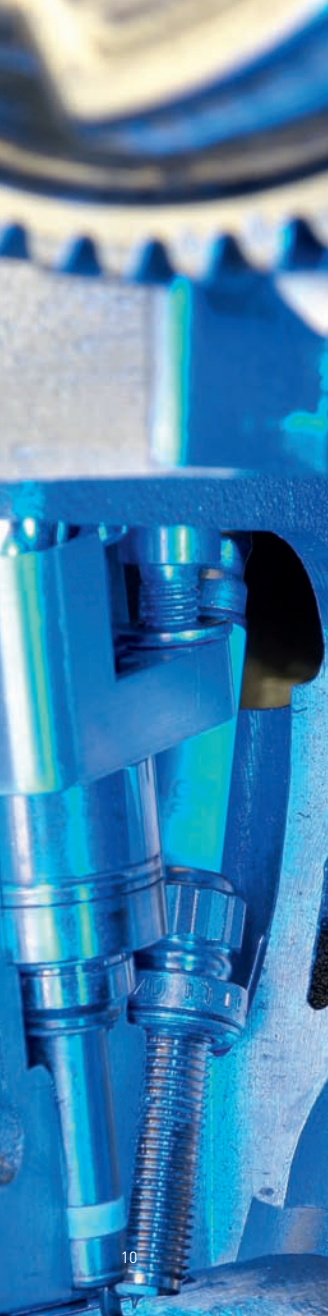

FOCUSED ON EXCELLENCE

As an engineering consultancy and manufacturer of premium cars designed to excite and perform, our breadth of technical knowledge and understanding is unrivalled. Although Lotus' cars are created for pure-bred performance, our clients often want help in other areas where our services and technologies are world leading.

Lotus Engineering focuses on four core engineering competencies:

- Lightweight Architectures
- Efficient Performance
- Electrical and Electronic Integration
- Driving Dynamics

We can tackle projects within each individual area or combine them to give us an unmatched ability to deliver anything from a component or system to a complete powertrain solution or whole vehicle programme. It is what we do.

The automotive industry is our heartland, but we do not constrain ourselves to this arena. During our long history, our innovative engineering approach and problem-solving expertise has been used by our clients from many other industries.

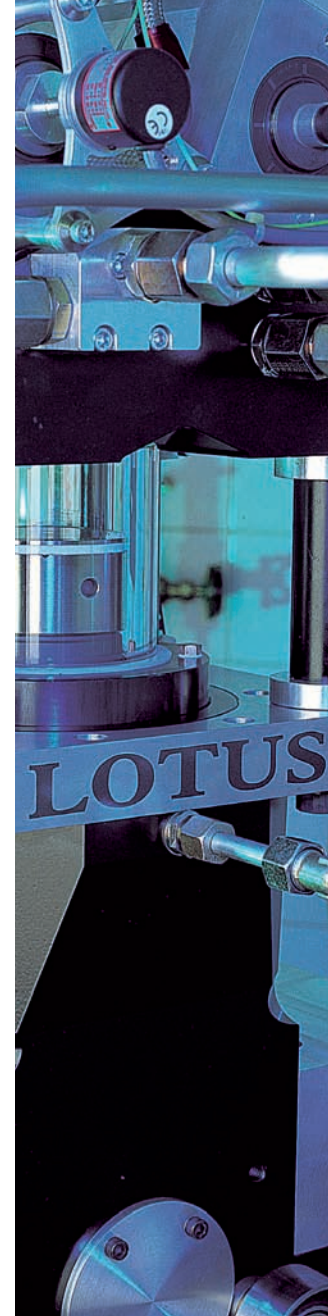



LOTUS IS GLOBAL

Lotus is a truly global business. We sell our sports cars in 40 countries around the world and they are engineered to meet the many different market and legislative requirements that each country demands.

This global presence is reflected in Lotus Engineering's consultancy business. Our clients include all the major automotive manufacturers, with newer companies from the emerging markets such as China and India forming an increasingly substantial part of our business.

So worldwide we may be, but we are linked-in locally with established engineering centres in the important US, Chinese and South-East Asian markets. It is not just being geographically close to the client that counts; we work hard to deliver our expertise and our innovation in a way that fits both culturally and practically.

Lotus Engineering's competencies are relevant across most global markets, but we realise that the way they are relevant can vary. We understand this and always work closely with clients to find the solution that best suits them. For one client, this may mean taking the project away to deliver a turnkey solution, while for others we may place expertise into the client's own team to lead the programme, get the job done and impart knowledge and experience to our customers' engineers.

EFFICIENCY, SUSTAINABILITY AND ENJOYMENT

We are not alone in recognising that the automotive industry must do more to address its environmental impact through reducing CO₂ emissions and improving the recyclability of the materials used.

We have always understood this – it is at the heart of the engineering principles that Colin Chapman instilled in the company that guide us today.

However, we are Lotus; we also believe that motoring, cars and engineering can and should inspire and delight. And the journey towards sustainable transport can and will provide thrilling, desirable, yet clean and efficient vehicles.

Technology for CO₂ reduction will be central to our engineering business, but applied in a way that provides enjoyment to the vehicle user.





- ECO TRIM AND SEATS**
 - ETHICALLY PRODUCED, BIODEGRADABLE, NATURAL FABRICS. FREE FROM DYES
 - STRONG, NATURAL MATERIAL. FARMED LOCALLY
 - REDUCES SOLVENTS. LOWER ENERGY PROCESS
 - RENEWABLE ENERGY TO HELP POWER THE ELECTRICAL SYSTEMS
- HEMP BODY BASED PAINT PANELS**
 - RENEWABLE ENERGY TO HELP POWER THE ELECTRICAL SYSTEMS
 - RENEWABLE ENERGY TO HELP POWER THE ELECTRICAL SYSTEMS
- SOLAR SYSTEM**
 - RENEWABLE ENERGY TO HELP POWER THE ELECTRICAL SYSTEMS
- FULL WATER BASED PAINT PANELS**
 - RENEWABLE ENERGY TO HELP POWER THE ELECTRICAL SYSTEMS
- ADVANCED AUDIO WHEELS**
 - RENEWABLE ENERGY TO HELP POWER THE ELECTRICAL SYSTEMS
- LIGHTWEIGHT DESIGN**
 - RENEWABLE ENERGY TO HELP POWER THE ELECTRICAL SYSTEMS
- HIGH PERFORMANCE**
 - RENEWABLE ENERGY TO HELP POWER THE ELECTRICAL SYSTEMS
- LIGHTWEIGHT DESIGN**
 - RENEWABLE ENERGY TO HELP POWER THE ELECTRICAL SYSTEMS
- IMPROVES PERFORMANCE**
 - RENEWABLE ENERGY TO HELP POWER THE ELECTRICAL SYSTEMS
- REDUCES FUEL EFFICIENT, GREENER PRODUCTION FACILITIES**
 - RENEWABLE ENERGY TO HELP POWER THE ELECTRICAL SYSTEMS
- PROMOTES FUEL EFFICIENT, GREENER PRODUCTION FACILITIES**
 - RENEWABLE ENERGY TO HELP POWER THE ELECTRICAL SYSTEMS
- WORLD CLASS, GREEN, LOW ENERGY PRODUCTION FACILITIES**
 - RENEWABLE ENERGY TO HELP POWER THE ELECTRICAL SYSTEMS



LEADERS IN OUR FIELD

Creating sustainable yet enjoyable transport is a perfect fit with Lotus Engineering's four core engineering competencies of:

- Lightweight Architectures
- Efficient Performance
- Electrical and Electronic Integration
- Driving Dynamics

The projects we undertake harness many elements from these four core competencies, which, when combined, can enable us to deliver complete powertrain projects through to whole vehicles, ready for manufacture.

Our expertise in combustion, valvetrain, pressure charging, electronics, bonding aluminium, noise, vibration and harshness (NVH), and chassis technology comes from years of sports and race car development and a huge array of projects for the mainstream automotive industry.

Our facilities, test cells, workshops, Computer Aided Design and Computer Aided Engineering (CAD/CAE) systems are among the very best, while broad and deep skill sets such as design, analysis, development,

problem solving and programme management are the hallmark of our engineering expertise.

This knowledge and our extensive facilities underpin a range of products and services, providing our clients with innovative solutions and clear engineering benefits.

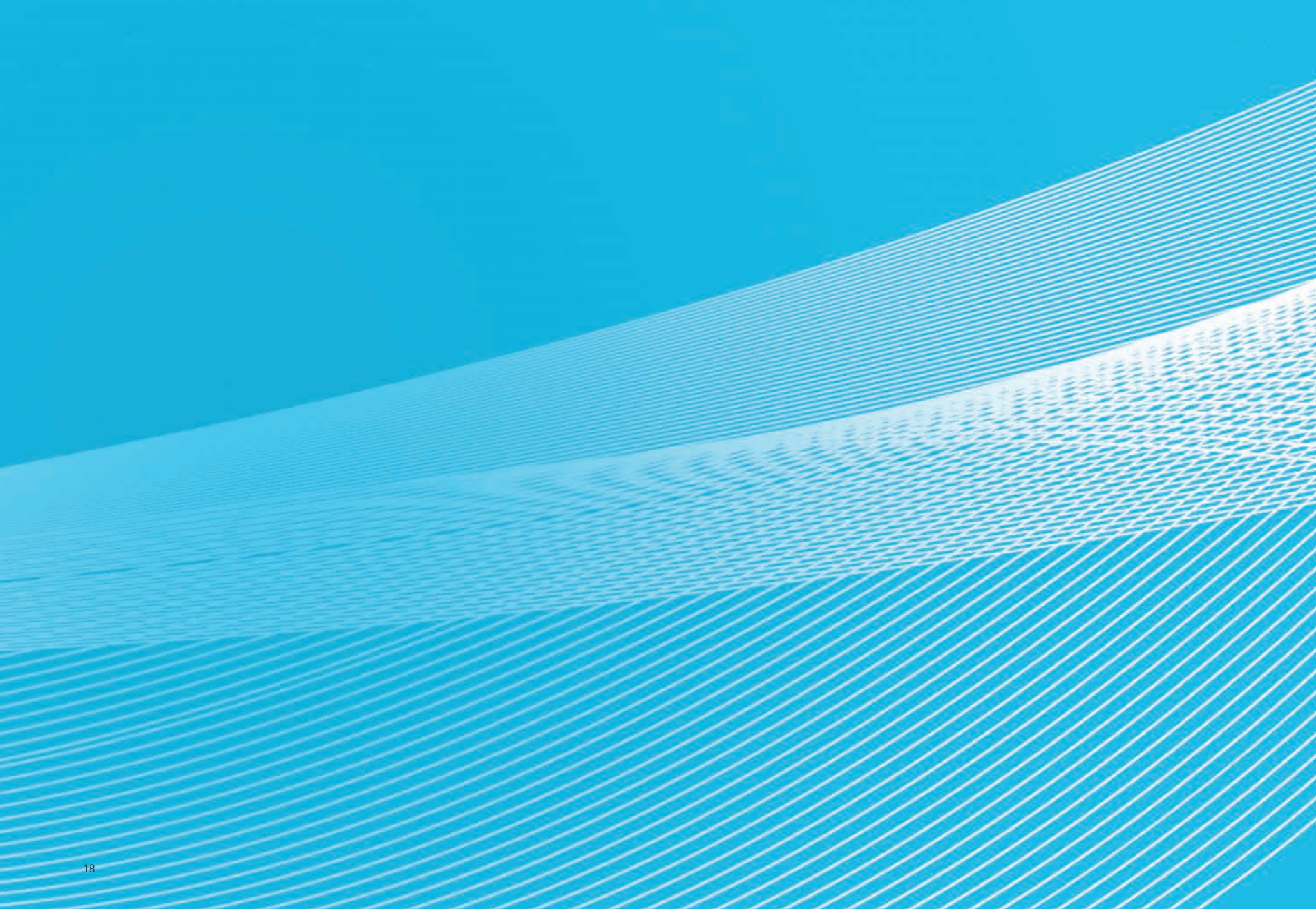

LIGHTWEIGHT ARCHITECTURES

A traditional Lotus solution is 'one with the least number of parts, effectively deployed'. With ever-tightening emission and environmental targets to consider, this core philosophy is more relevant today than it has ever been to the automotive industry.

Reductions in mass result in tangible improvements in fuel economy and emissions performance. As a car manufacturer, we understand the need to find the most efficient and cost-effective solutions.

Lotus is technology and process independent. With knowledge and expertise in metallic and composite materials for both low and

high volume manufacturing, we are a world-leader in lightweight structures and vehicle integration.

So, whether creating a new vehicle architecture, developing low-mass solutions for existing vehicles or using an existing Lotus platform, we are ideally placed to help our clients produce more efficient vehicles that exceed the expectations of their customers.

BESPOKE PLATFORMS FOR THE CLIENT



Our Elise demonstrates how Lotus harnesses new technologies – bonded aluminium extrusions and composite crash structures – to create the base for industry changing niche vehicles, not only for our products but for clients.

The recent Lotus Evora shows we have the ability to develop and engineer bespoke, all-new, commercially viable platforms in rapid timescales – the Evora went from concept to production in just 27 months. This expert

knowledge in combining the appropriate technology from both high and low volume design and manufacturing enables us to execute the best engineering solutions to meet stringent requirements.

Bespoke platforms can pose a complex challenge to meet all the performance, functionality, brand and commercial targets of a client, not forgetting the necessary legislation and type approval criteria.

We have been designing and assembling globally type-approved platforms for many years. Lotus has the culture, expertise and experience to engineer thrilling vehicles that, importantly, make sound business sense. We can combine appropriate low

and high volume techniques, processes and methodologies in ways unfamiliar to most in the industry, with a unique blend of passion and commercial pragmatism. This enables us to deliver truly individual vehicles and platforms within economically viable programmes.



PROVEN PLATFORMS FOR SUCCESS

Lotus is in an enviable position when it comes to creating niche vehicles and our expertise and skills can be exploited by other manufacturers quickly and cost-effectively adapting our existing platforms as the underpinnings for their own range of vehicles.

Commercial constraints often mean that many manufacturers try to base a niche sports car on current mass-market cars:

sometimes this works, often it does not. Using Lotus' platforms can provide a high performance, lightweight solution to maximise handling and driver enjoyment, while being highly adaptable.

Our award-winning small car platform has been in production for more than a decade and has formed the basis of a range of cars including the Elise and Exige. It is compact and lightweight, and offers clients a low-investment, quick-to-market solution for niche vehicles where the overriding factors are supreme handling and driver enjoyment.

The Evora platform also offers a fast-to-market, proven platform for high performance sports cars. It uses a lightweight, modular aluminium chassis which, like the Elise/Exige platform, can be adapted as a basis for client vehicles.

It too has won praise and awards around the world for the uncompromised yet refined driving experience it delivers, meaning that the class-leading platform can provide the foundation for striking and truly captivating performance cars.

The next generation platforms that are the basis for future Lotus products will present our customers with even more scope to create exciting, dynamic and stunning driver-focused cars.



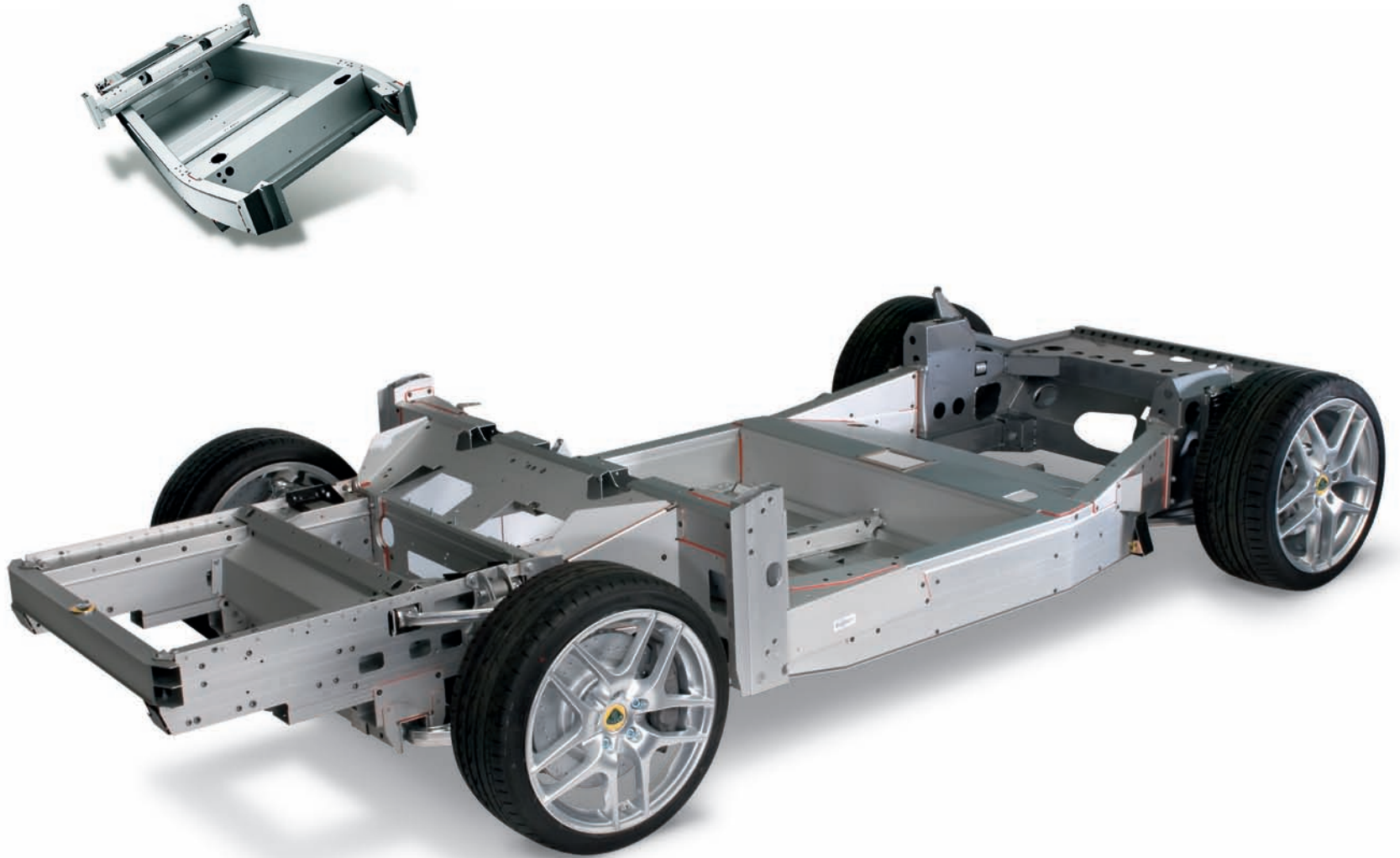



LIGHTWEIGHT IS THE RIGHT WEIGHT

We have a proven track-record in producing light yet strong structures that feature at the heart of our own cars.

The same approach is applied to all our engineering design for lower-mass components, systems and whole vehicles. We combine intelligent design, weight down processes and component integration with the selection of lightweight materials and the latest joining technologies.

Lowering weight gives many key benefits. A 30% reduction in mass typically gives a 10% improvement in fuel economy and CO₂ emissions. There is also the potential for reduced material costs thanks to

part integration, while lighter vehicles benefit from improved dynamic ability and driver enjoyment.

For both high and low volume applications, we can offer a full design and development service, including CAE optimisation through to the construction of prototypes. And where the volumes are low, we can provide a manufacturing solution for composite structures or, through our Lotus Lightweight Structures manufacturing operation, aluminium assemblies such as those for our own products.

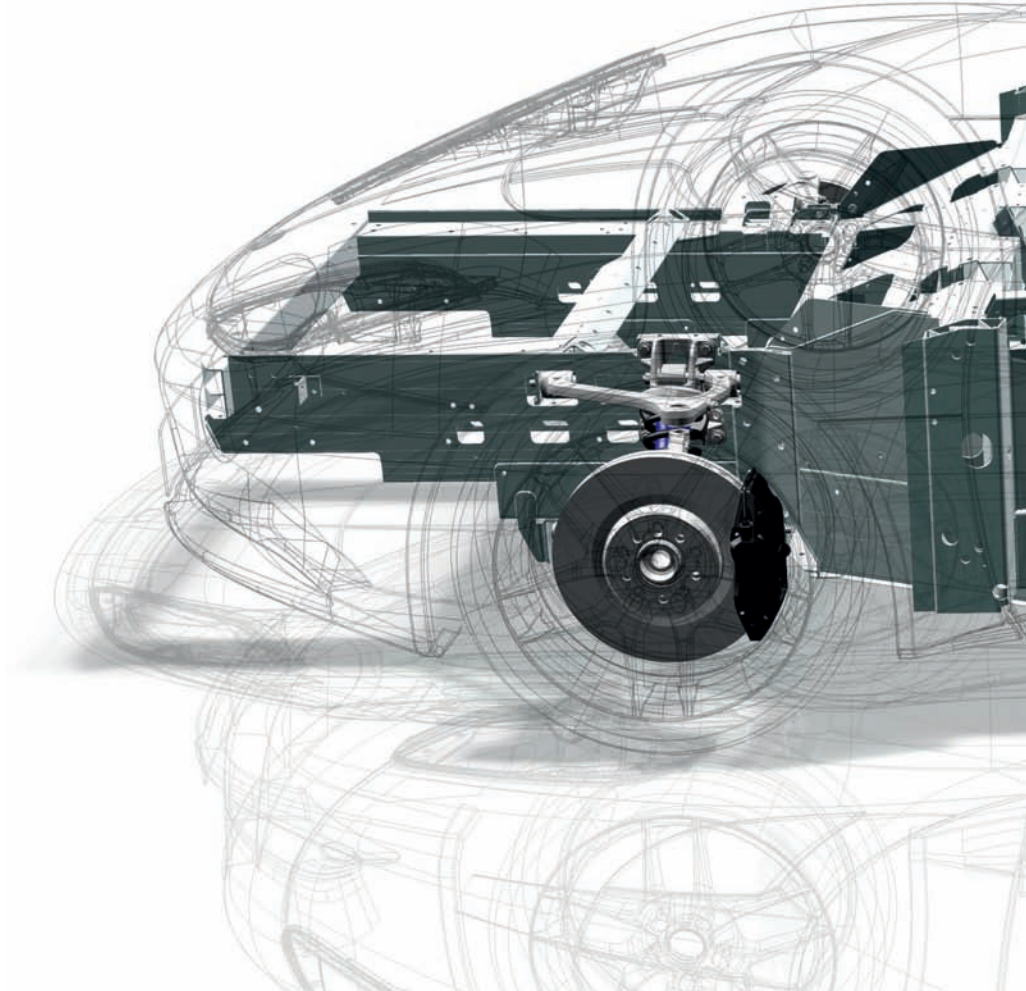

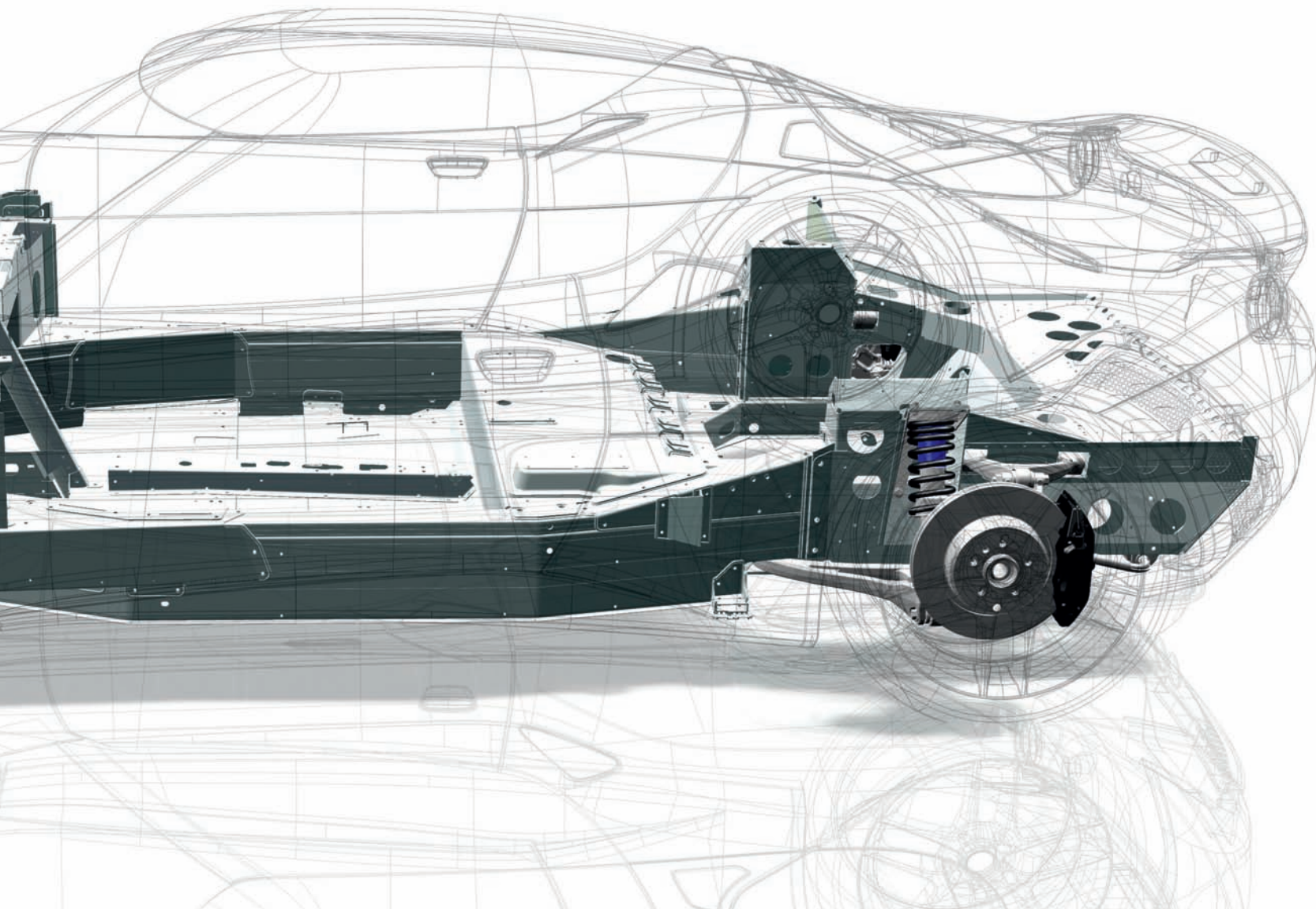

EFFICIENT PERFORMANCE

Improving efficiency while maximising performance – this has always been at the heart of Lotus' philosophy.

Today, this has more relevance than ever before, as there is a real urgency to slow the decline of fossil fuel reserves and reduce emissions. As a car manufacturer, Lotus understands the need to find efficient and cost-effective solutions to meet these challenges while maintaining a viable business case.

This means we are ideally placed to help our clients produce more efficient

vehicles and powertrains that do not sacrifice performance.

Lotus Engineering's approach for minimising the CO₂ impact of transport is to focus on improvements in the areas of engine efficiency, alternative powertrains and reducing the CO₂ footprint of the fuel or energy source for the vehicle.

There is currently much investigation into alternative forms of propulsion, but making conventional internal combustion engines even more efficient remains a priority.

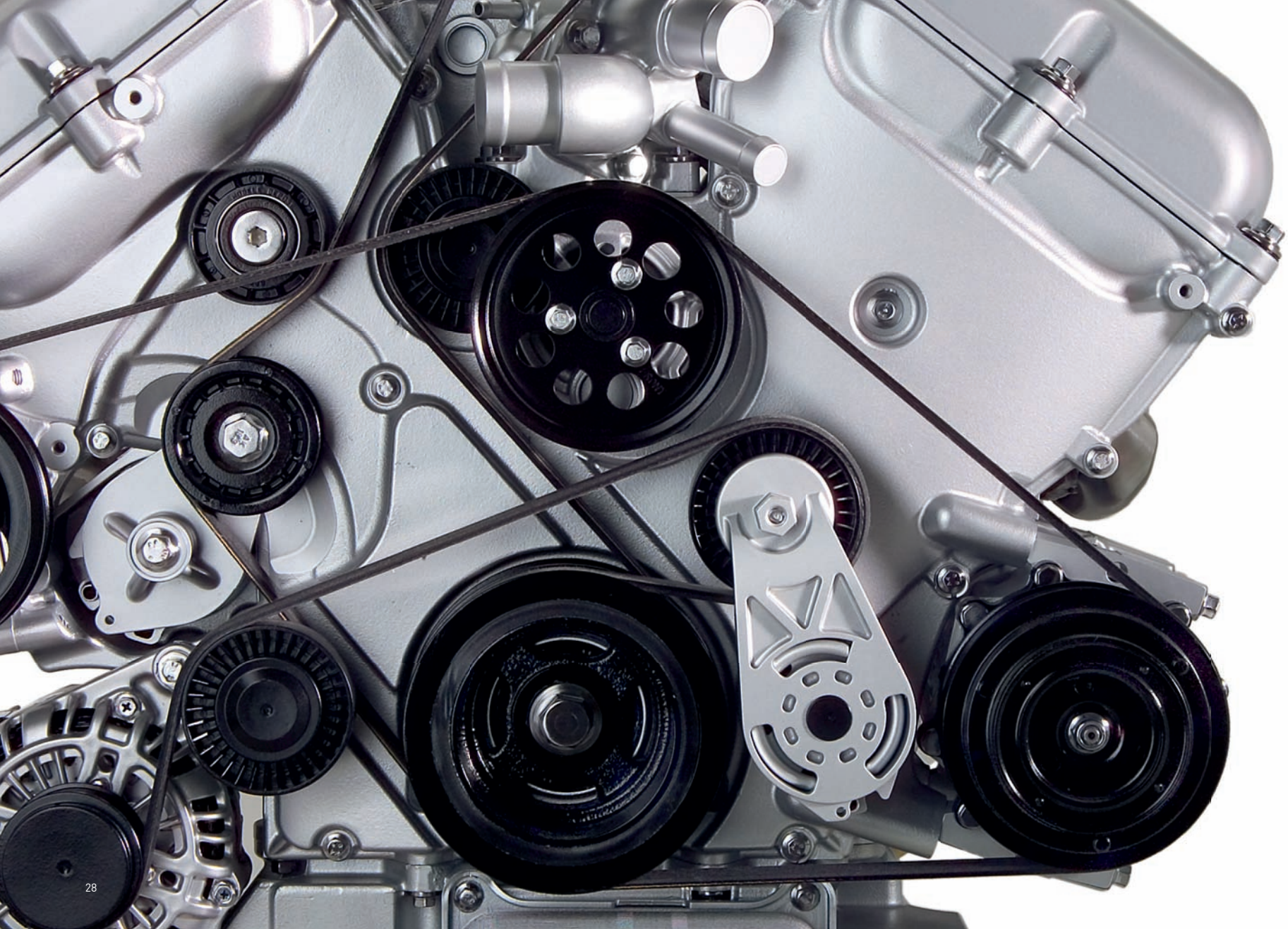

FRESH IDEAS CLEANER ENGINES

We have a history of pioneering new engines, for both road and track, with a proven ability to design and develop powertrain architectures for clean, efficient engines using technology that is suitable and viable in series production.

Smaller, more efficient, but more powerful engines are recognised as an important route to cleaner

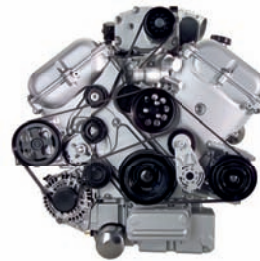

transport. Our knowledge of combustion, engine design, calibration and production places us at the forefront of downsized engine development. And with pressure charging, direct injection and new valvetrain technologies fundamental to effective engine downsizing, our impressive track record with these technologies makes us the experts in this field.



Importantly, we also realise that the engine is integral to the whole driving experience, so our approach is to resist the temptation to downsize too aggressively at the expense of driveability and responsiveness. We have the expertise within Lotus to design and produce cost-effective downsized engines that result in vehicles that are a pleasure to drive.



With new engine architectures, we know that sometimes challenging convention for better emissions, performance and cost can also be the best way forward. Projects such as OMNIVORE and the Lotus Range Extender engine are two of the most recent examples of Lotus Engineering again pushing the boundaries of engine technology.

It often makes sense to upgrade and apply new technologies to existing powertrains to enhance performance, improve efficiency and emissions, and adapt the engine to new applications.

For the client, this provides the benefits of longer life for their existing engines while adapting to changing

consistent with fun-to-drive, more efficient vehicles.

How the engine fits into the vehicle is important, and with our wider expertise in many aspects of vehicle engineering, we can ensure that engines can be fully integrated with the vehicle package, fuel system, chassis system and electrical architecture.

UPGRADES AND NEW APPLICATIONS

market requirements providing further choice to their customers through an expanded product range.

We have decades of powertrain integration experience and we are experts in pressure charging, valvetrain technologies and engine control, all key to extracting great efficiency, performance and longevity from engines. We have an approach that concentrates on technologies that are affordable and practical for production, while still being

Calibration and software experience, and our own control systems for niche applications, enable us to achieve desired performance characteristics for a range of powertrain and fuel types whilst meeting future legislation.

Through our complementary expertise in hybrid and electric vehicles, we can also adapt engines for hybrid applications.

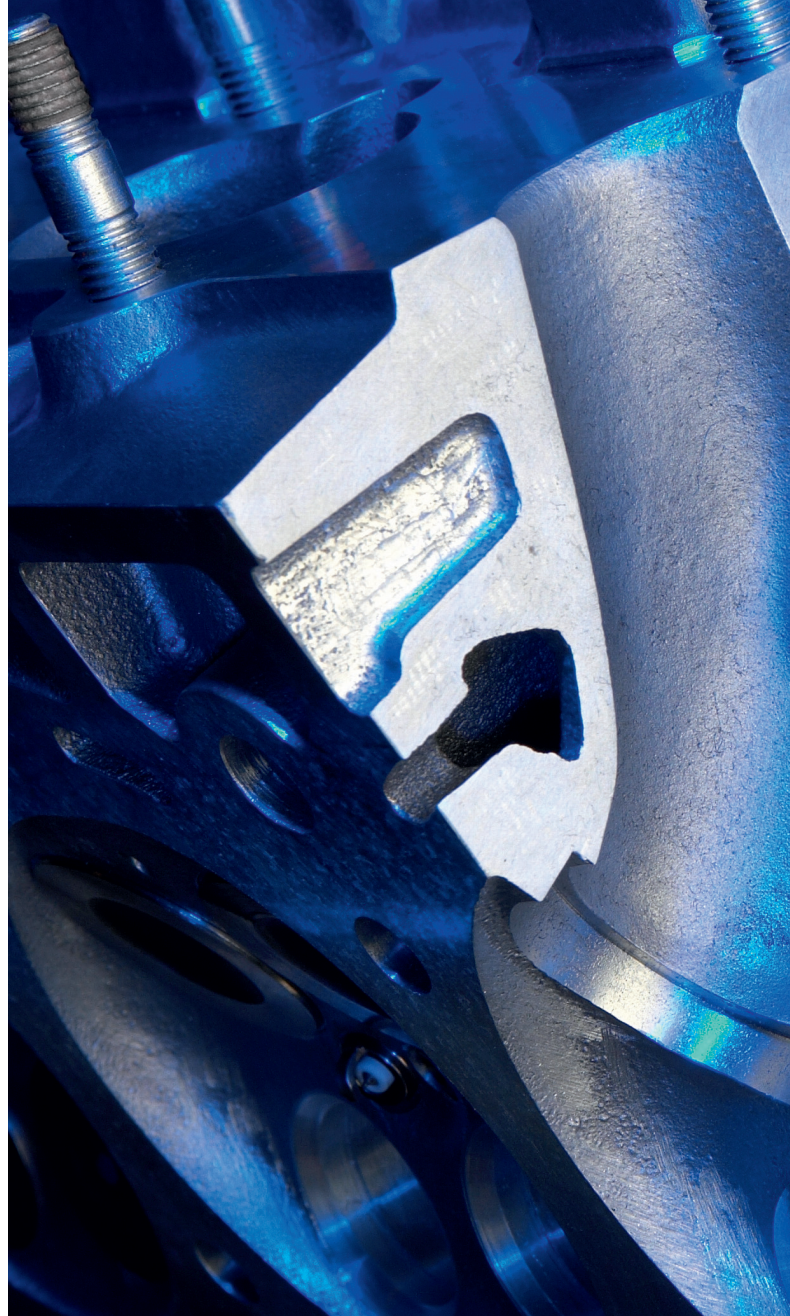

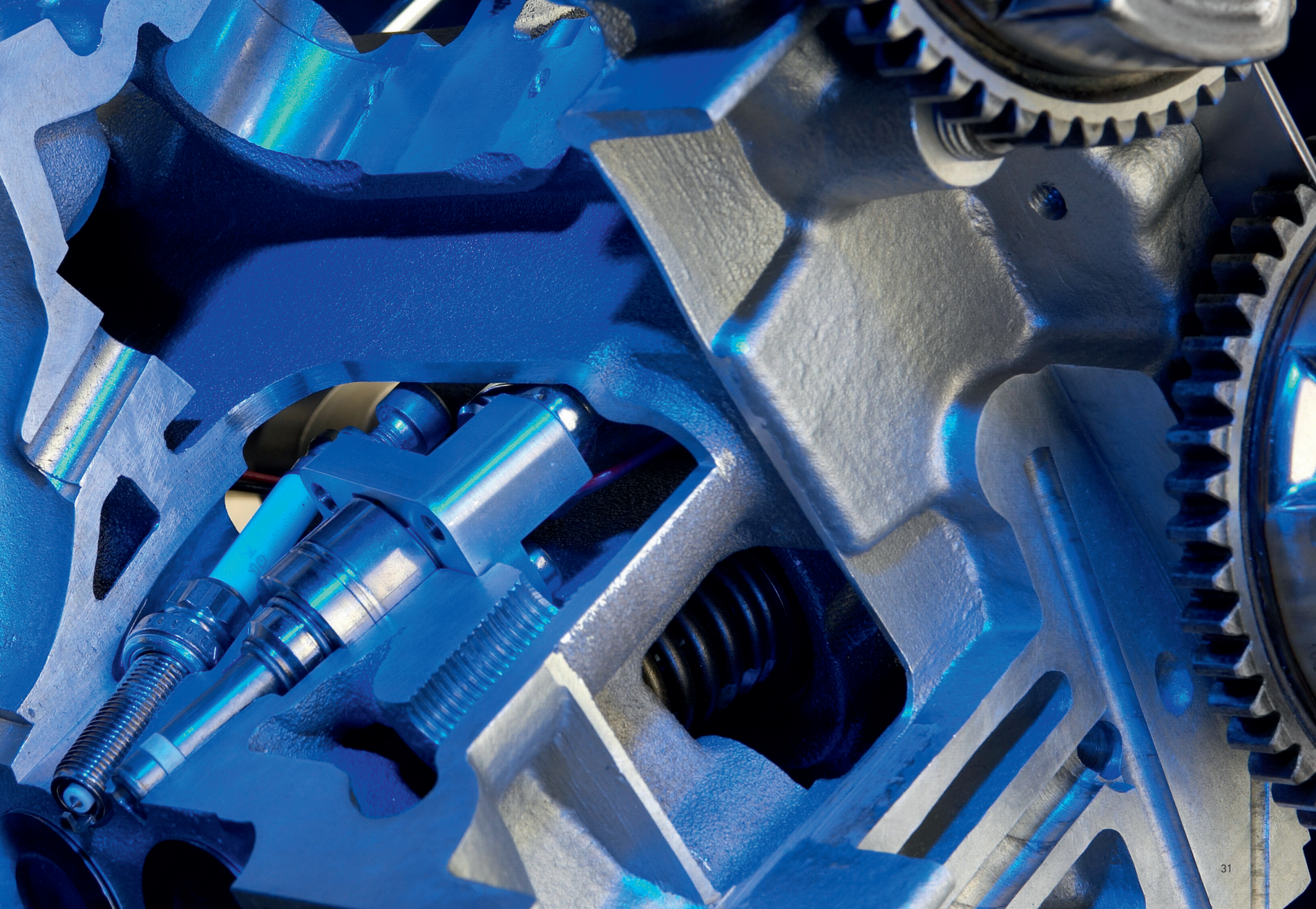

ALTERNATIVE FUELS – PURE PERFORMANCE



At Lotus, we have embraced the challenge of ever-stricter emissions and diminishing oil reserves and shown that environmentally-friendly performance cars are a reality. Some alternative fuels better suit certain geographic locations, but we believe that renewable and alcohol fuels can begin to replace conventional fossil-based fuel sources and that as well as reducing CO₂, they can offer performance benefits too. We have worked

with many alternative fuels and the Exige 265E Biofuel and the Exige 270E Tri-fuel demonstrators have been important in this.

Lotus has proven expertise in enhancing performance and reducing emissions using alternative fuels and can offer viable and immediate solutions for greener cars. We have created biofuel-compatible engines and fuel systems with flex-fuel calibration that fully comply with emissions regulations.

Looking to the future, our OMNIVORE concept promises a fully-flex fuel engine running on gasoline, diesel and alcohol fuels that is far more efficient than today's engines.

Pushing the boundaries further, we are working on the development of future alcohol fuel blends that can support the increasing demand for ethanol.



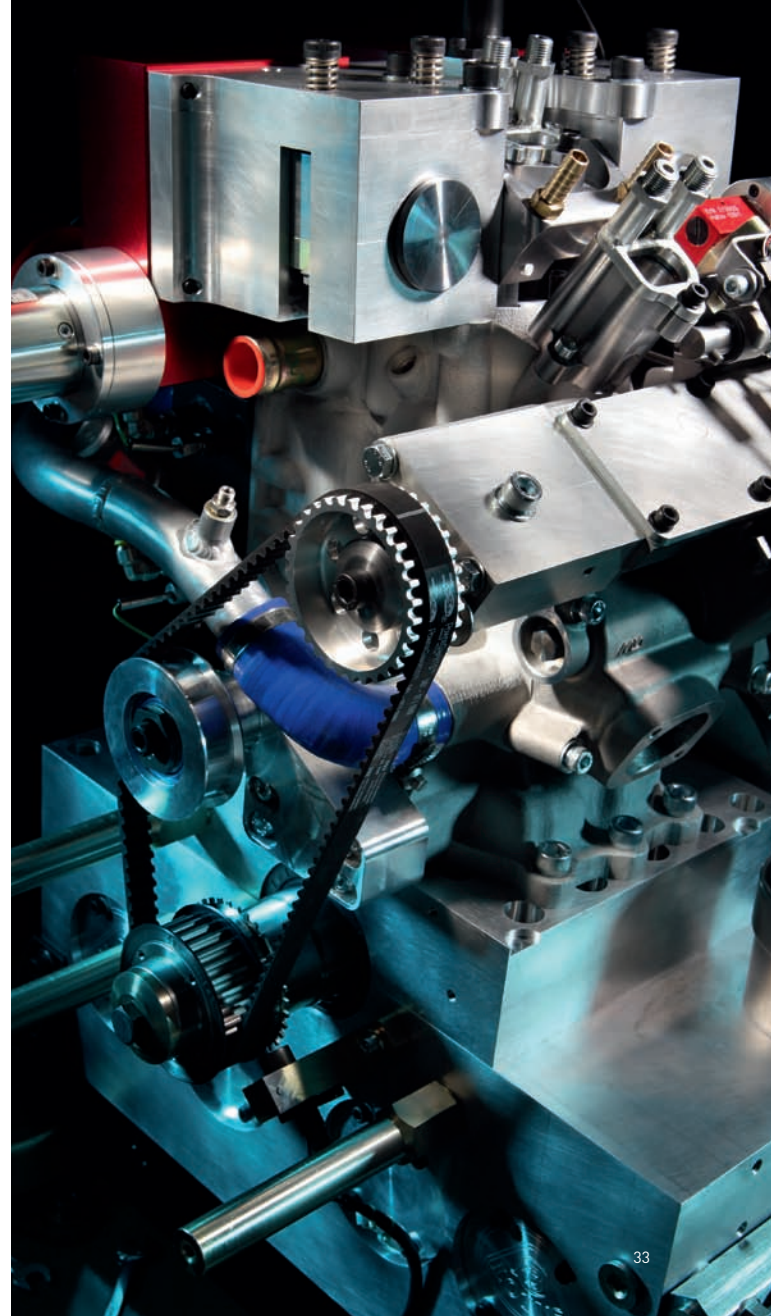



ELECTRICAL AND ELECTRONIC **INTEGRATION**

Lotus Engineering is an established industry leader in creating hybrid and electric vehicles incorporating a range of technologies. Integration of new drivetrain solutions presents a perfect opportunity for Lotus Engineering's combined skills to shine. Hybrid and electric vehicles pose a unique set of challenges on many fronts, ranging from unconventional packaging, control systems, software and strategy through to wider-ranging manufacturing issues.

However, our electrical and electronic integration expertise extends far beyond propulsion systems into vehicle control systems, comfort systems, infotainment and creating advanced human machine interface systems. Niche and premium applications are often where emerging technology is first implemented to give vehicle users new functionality. It is this area where our electrical and electronic control technologies and expertise

are invaluable in helping clients quickly bring integrated solutions to production.

So, our ability to integrate next generation technologies using a whole-vehicle perspective not only helps our clients deliver on their environmental promise, but also creates desirable, customer-focused vehicles.

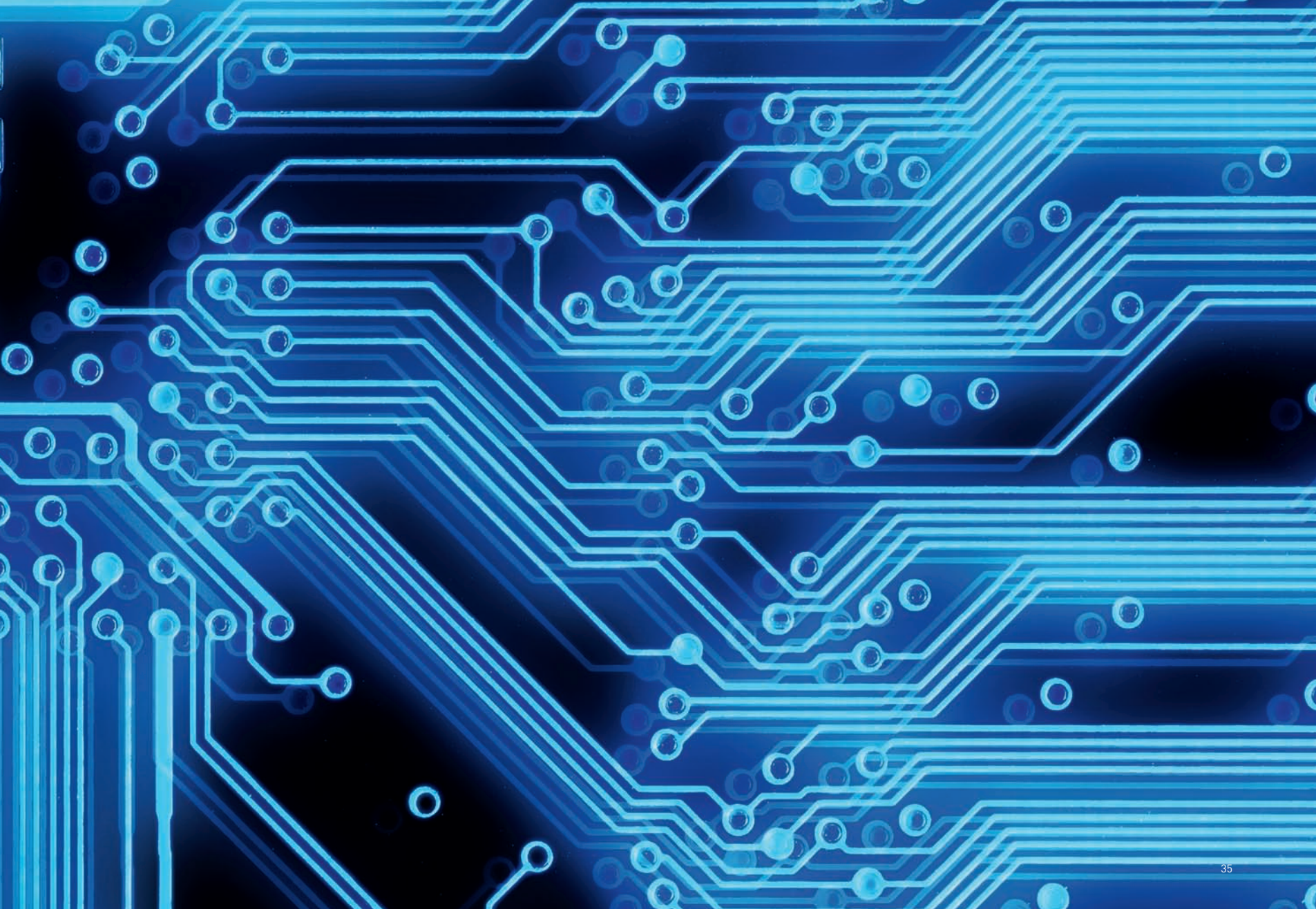

HYBRID AND ELECTRIC VEHICLES – CHARGING AHEAD

We have over two decades of experience in building electric and hybrid vehicles.

The challenges they pose are well-suited to the breadth of skills and expertise within Lotus Engineering. Our experience in control systems, electrical integration and engine design complements our 'whole vehicle' knowledge that comes from us being a car manufacturer. This means we can help create practical, efficient hybrids which are viable for production.

We can engineer complete powertrain systems for single technology demonstrators or support full production programmes with different

propulsion configurations, ranging from micro-hybrids through series and parallel hybrids to battery electric vehicles. Hydrogen fuel cells or internal combustion engines for extended range are areas where we are also currently working, and we have developed the Lotus Range Extender engine specifically for hybrid applications.

Whatever the vehicle specification, we define and integrate all major components and systems including motors, batteries and high and low voltage electrical systems with the overall vehicle architecture.

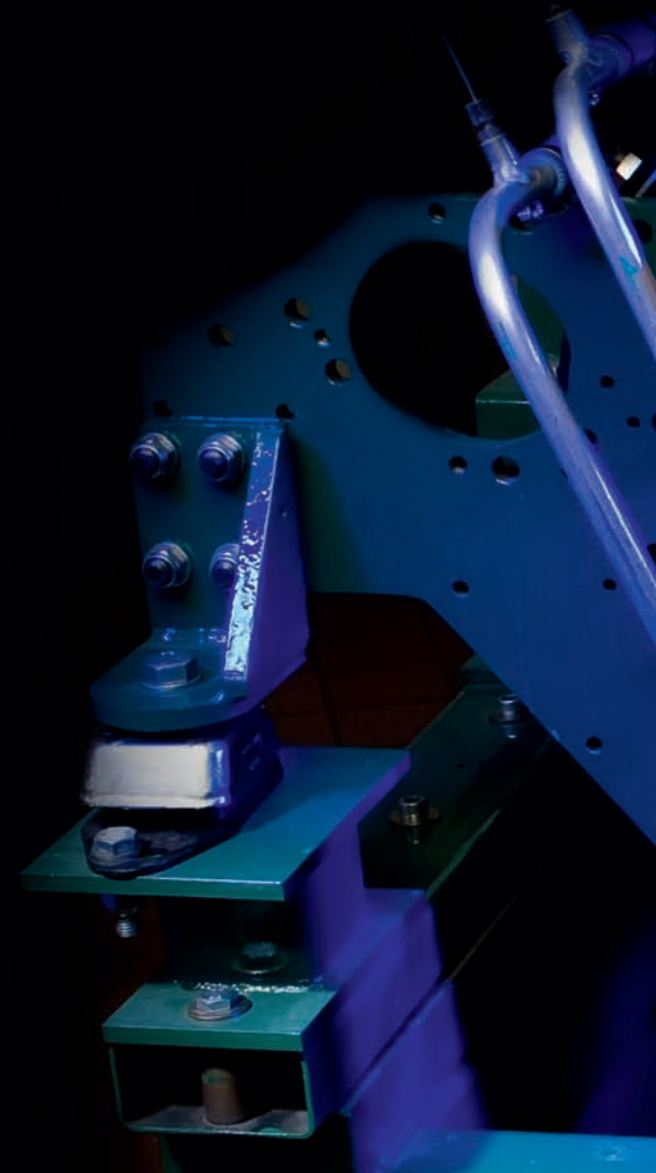

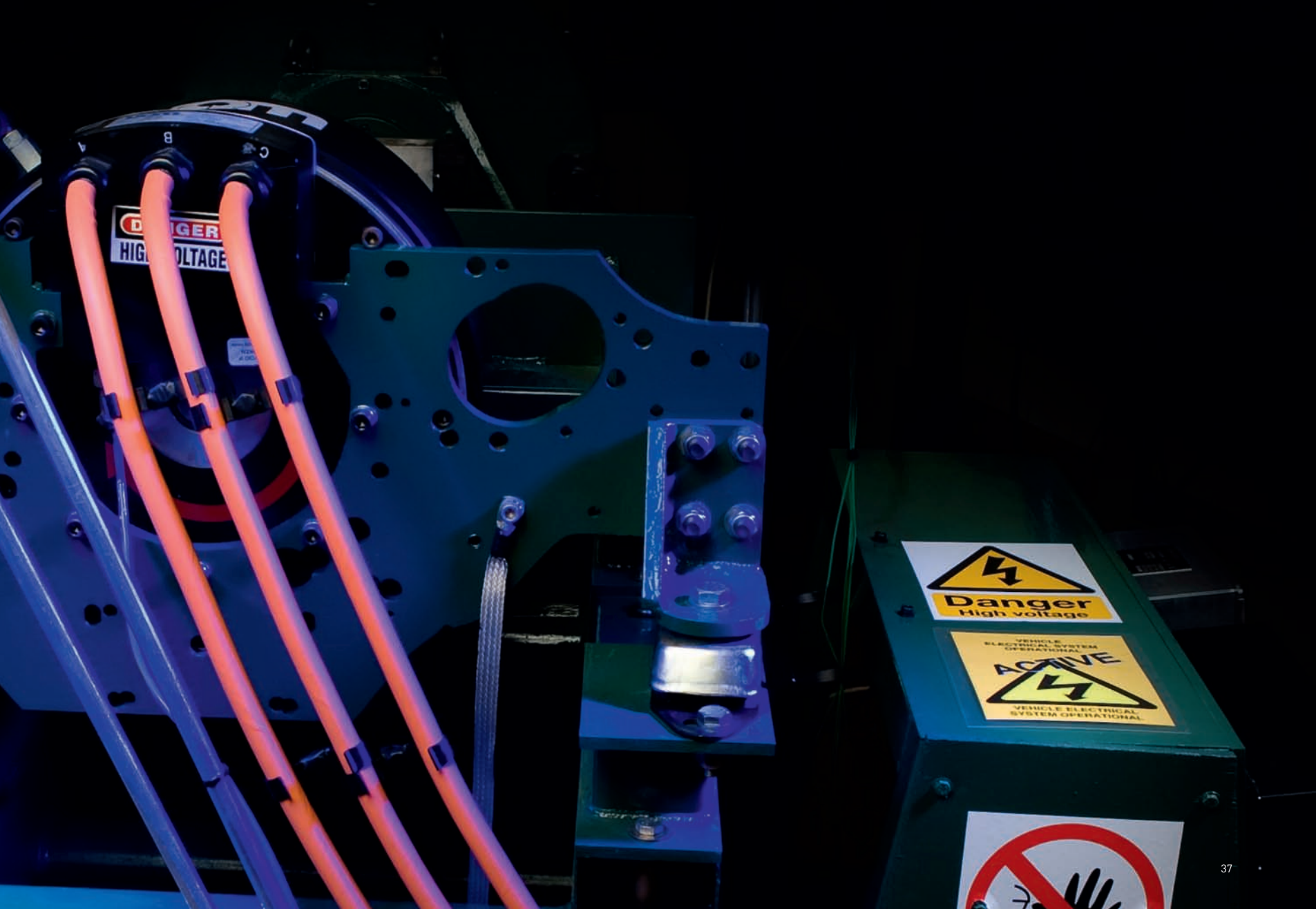

DANGER
HIGH VOLTAGE

Danger
High voltage

VEHICLE ELECTRICAL SYSTEM OPERATIONAL
ACTIVE
VEHICLE ELECTRICAL SYSTEM OPERATIONAL





IN FULL CONTROL



Control systems are an integral aspect of today's vehicles, from safety, stability and security systems, through all aspects of powertrain and propulsion to the total human machine interface. Increasingly, with the adoption of these control technologies, vehicle attributes and product differentiation is often defined by electronic systems and settings.

We have expertise in the complex electronics of all vehicle systems and can use our own technology to work with, or substitute for, individual systems' controllers within engineering programmes for cost-effective results. Our skills and experience also allow fast and effective

integration of many separate vehicle systems, even if they have not previously been used together for an application.

We can define and implement the complete control system requirements for production, developing software and integrating hardware elements across the whole vehicle for improved efficiency and functionality, promoting brand character. Our own Lotus control systems offer production solutions for lower-investment, faster to market options that are flexible and adaptable for a wide range of client applications. We use them for our own cars, so we understand design of control systems for safety and durability.

MAN AND MACHINE

In an increasingly electronic world, how the occupants engage with the vehicle is paramount. This is especially true of the niche and premium market, where customers have a desire for the latest technology to enhance the entire driving and owning experience.

People want more information than ever from the vehicle itself, while enjoying

entertainment, better comfort and increased connectivity between the vehicle and the outside world.

Lotus can create high technology Human Machine Interfaces designed to improve the way the user interacts with the vehicle.

This can provide the integration of vehicle controls for improvements

in functionality, design, cost and vehicle efficiency. It gives the vehicle a competitive advantage, helps the brand stand out from the crowd and gives the vehicle user greater enjoyment and practicality.

We have an established background in delivering complex control and electronic systems, integrated fully with other vehicle systems for prototype

and niche volume production. We also work with a supplier network to provide fast, low-investment programmes suitable for low and medium volume production and have experience of developing user displays and interfaces for electric and hybrid vehicles.



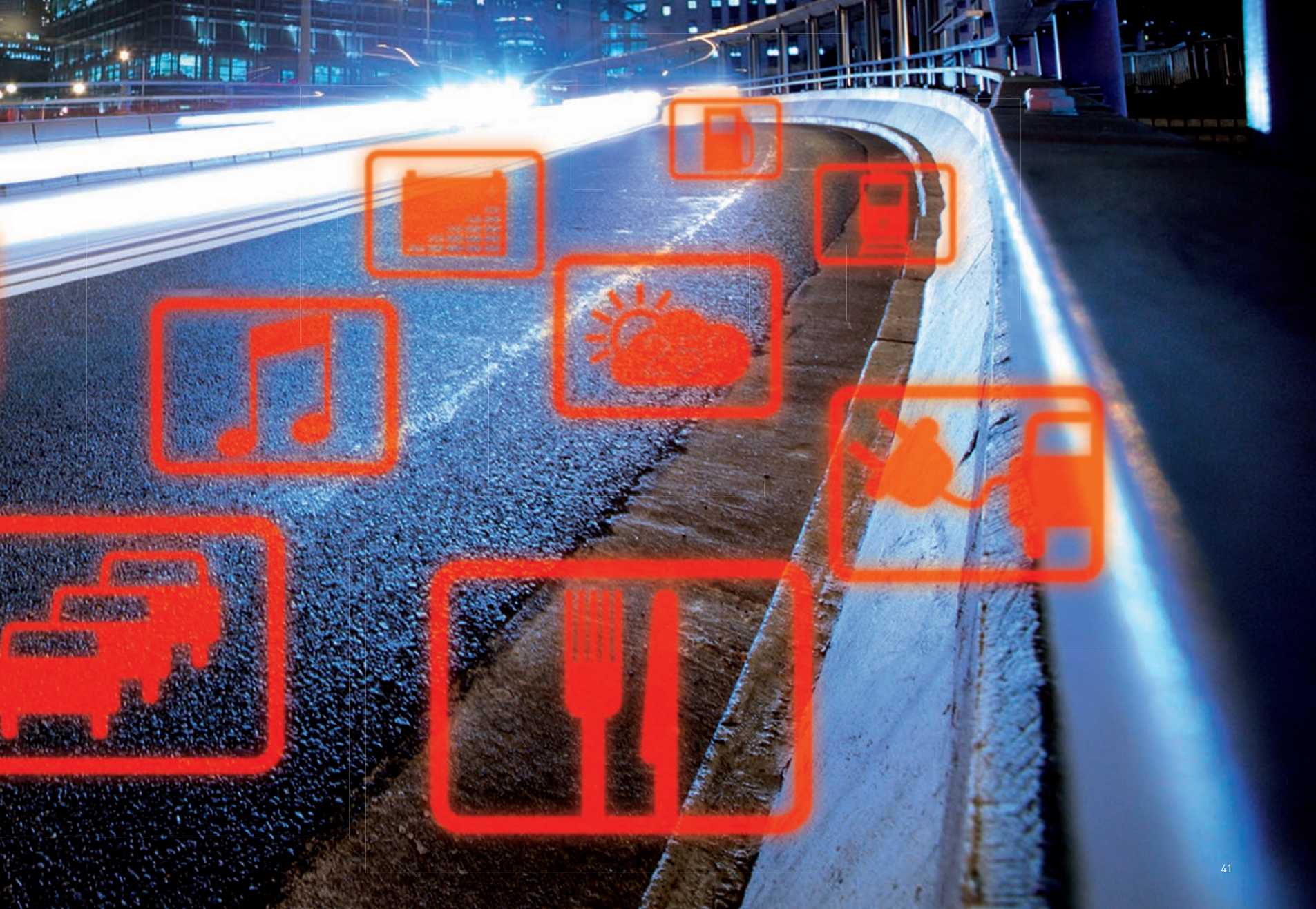





DRIVING DYNAMICS

We are the world-leading consultancy for driving dynamics. It is a core part of our brand and no-one offers a more comprehensive understanding of the delicate interaction that exists between vehicle and driver.

Driving dynamics are vital; not only do they help satisfy customer desires, they add to vehicle safety and help define the values of the product and brand. They encompass how the car performs and responds, how it sounds and how it makes the driver or passenger feel. It is an art and a science to create the dynamic character to define a vehicle and meet the needs of the user.

Lotus has a deep understanding of how to unite all aspects of driving dynamics – ergonomics, vehicle dynamics, aerodynamics, NVH, performance and safety – to create the right overall driver experience for the vehicle.

At Lotus, we are skilled at manipulating all the elements of driving dynamics to create a driving experience that matches our client's expectations and those of the vehicle occupants.



IN THE DRIVING SEAT



Vehicle manufacturers are constantly striving to build or maintain a brand identity to differentiate themselves and their products. Driving dynamics attributes are crucial to this, often the difference between success and failure of the product.

Understanding all the technical influences on the driver's perception and experiences are the key to getting the driving dynamics right.

We engineer the vehicle from a customer's viewpoint to achieve a more balanced solution so that the customer reaction never comes as a surprise.

Our proven approach is to consider holistically, rather than in isolation, all the driving dynamics attributes, including ride, handling, steering, aerodynamics, NVH, performance and ergonomics. Together they define the overall driving

dynamics of the vehicle and a car that feels good to drive is one that consumers want to buy. We should know; driving dynamics are central to the success of our own cars where we have an unsurpassed history of ride and handling excellence.

However, from passenger cars to trucks and buses, we understand all vehicle sectors across all markets – not just sports cars.

AN ART AND A SCIENCE

No-one offers a more complete understanding of the interaction between vehicle and driver, all the way through from the initial design stage to on-road development and testing.

We couple subjective vehicle assessment by our expert engineers with state-of-the-art objective testing

and simulation techniques. Computers, technology and raw data can help to quantify driving dynamics, but ultimately it's the driver behind the wheel that needs to be impressed and kept safe.

Key to this is specialist engineers from across technical disciplines working closely together to arrive at

the optimum solutions. This integration of the different functions combined with our focus on the end-user experience makes the Lotus approach unique.

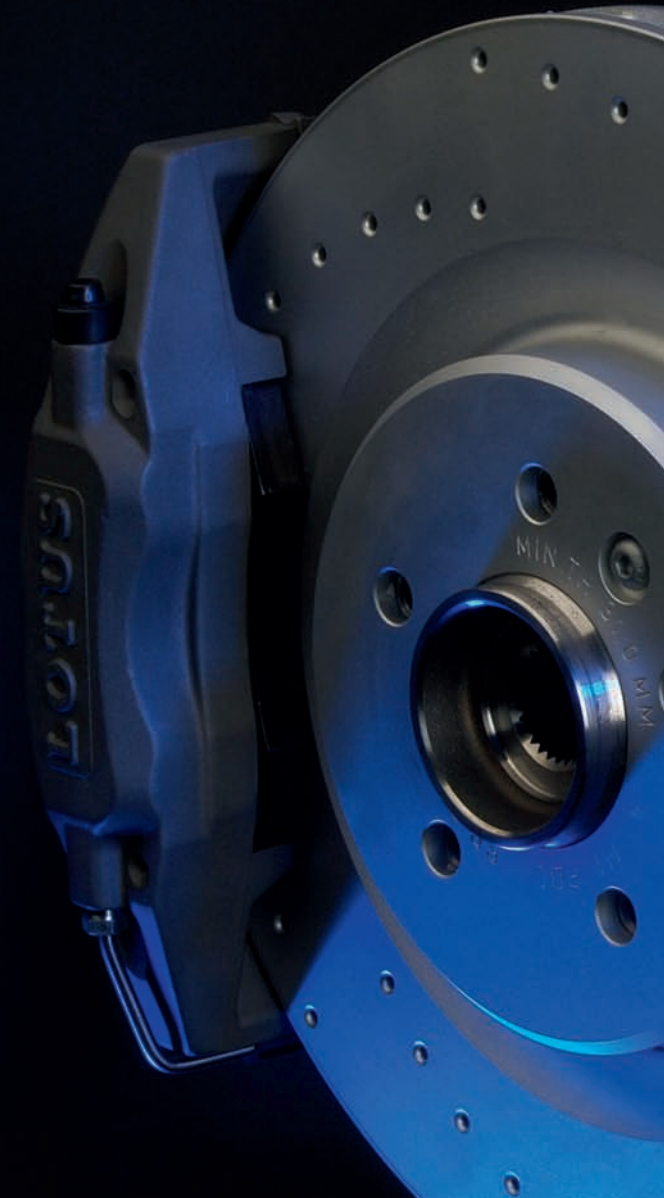

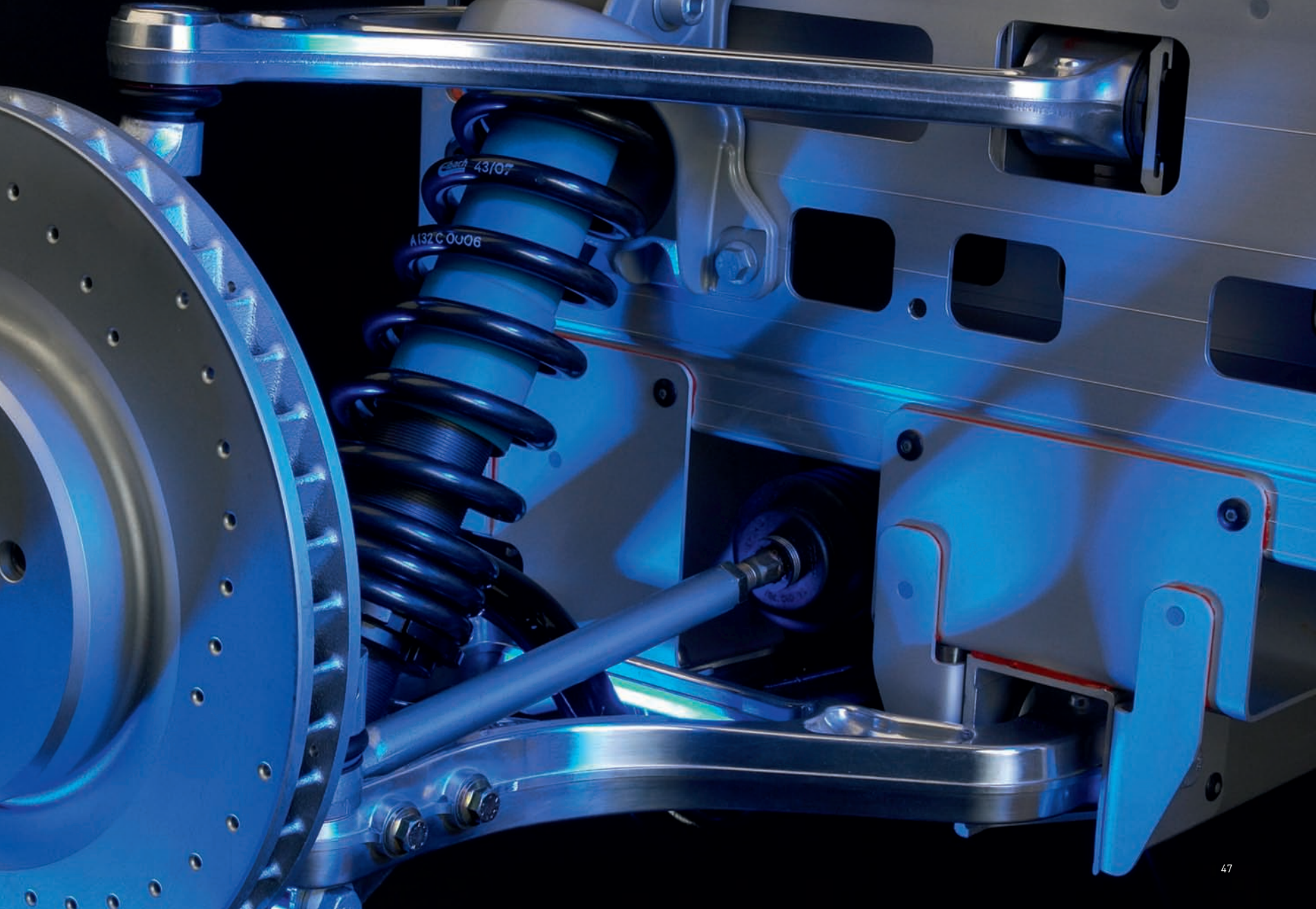

43/07

A132C 0006



SOUND ENGINEERING



Throughout our history Lotus has always embraced new technology. Today, active control technology remains a field in which we are a world-beater since pioneering its use in Formula 1 in the 1980s. Active dynamics technology has the power to revolutionise driving dynamics and we are dedicated to pushing those boundaries of comfort, fun, safety and efficiency – improving the inherent dynamic envelope.

The driving experience is heightened, safety is improved, efficiency increased and brand character is enhanced.

Active technology is also leading to improvements in interior sound in vehicles and pedestrian safety.

Our production-ready suite of Lotus-patented active noise control technologies can be integrated into the vehicle's in-car entertainment system. The interior systems can

enhance the in-cabin sound quality and character. External sound synthesis addresses the issue of pedestrian safety for electric and hybrid vehicles which are hard to hear at lower speeds due to their quiet drive mechanism.





A WORLD-CLASS COMBINATION

With new legislation, technology, and customer demands moving and fragmenting the marketplace, increasingly, there is a call for more specialised, imaginative cars – exciting niche vehicles.

Throughout our history, we have used and developed our expertise to produce dynamic sports cars of our own and exciting, desirable vehicles for our clients.

Today, with our four core competencies encompassing many aspects central to creating such vehicles, we can bring these together to deliver vehicles that, through design, performance,

technology and individuality, can enhance a brand and redefine the market.

However, niche vehicles do represent a different set of challenges; to be viable, product, commercial and manufacturing considerations must be carefully balanced.

Our advantage is that we have both a passion for the product and the know-how to engineer innovative vehicles. Aspects of our values and philosophy embodied in our own products are often what is needed by our clients to enhance their own vehicles – we can engineer any type of vehicle so that it truly engages with the customer.

FULL PROGRAMMES – THE TOTAL PACKAGE



Our four core competencies and the wider skills within Lotus provide a depth of experience and expertise to engineer whole vehicles across a range of vehicle types, market sectors and production volumes.

We have the management capability and processes to deliver programmes using combinations of both our internal engineering teams and external partners and suppliers, to provide the best delivery solution for the client.

For low volume products, or vehicles most closely aligned to our own sports cars, we typically undertake the vast majority of the engineering activity using our in-house teams. For higher volume projects, we carefully manage the delivery of some elements by key partners or production suppliers.

In all cases, we can take responsibility for the whole project and will always look to undertake those parts of the programme that fall within our areas of key expertise. It is important that the cars we deliver for our customers reflect the value we provide.

We are experienced in working to clients' processes or our own, and whatever the exact programme requirements, we always work to highest industry quality standards.









FUTURE THINKING

Innovation has always been at the heart of Lotus and is needed now more than ever as the automotive world faces up to new environmental challenges.

Whether it is new technologies in engine design or control, changes to automotive energy sources or examining and pushing the boundaries of new types of vehicles such as electric cars and hybrids, we are at the forefront of many automotive technologies.

We have always recognised that lighter vehicles are cleaner and more efficient, and this is more relevant

today than ever before.

That is why we continue to evolve our use of aluminium and bonding techniques, the end results of which will be seen in a variety of exciting production cars launched in the coming years. We are also looking at ways to make lightweight structural composites viable for higher volume applications.

Sustainable materials are now an important part of our research activity, and across all aspects of transport technology we are developing detailed understanding of the whole life cycle impact of transport technologies on the environment.

IN PURSUIT OF **KNOWLEDGE**



The powertrain research we do here at Lotus Engineering continues apace and has a direct impact on the activities of much of the automotive industry.

Our own research is pushing the boundaries of in-cylinder combustion understanding, using a range of advanced single-cylinder engines that can be configured to emulate different powertrains and use different fuels. Our research systems, including optical access engines and Active Valve Train (AVT™), are in use at many vehicle manufacturers and universities around the world.

To exploit the advantages of alternative fuels and improved combustion techniques, we are pursuing truly flex-fuel engine concepts that can run on many different fuels, efficiently and cleanly. It is an important, exciting focus for Lotus as we help shape a more efficient future.

New propulsion technologies, particularly increasing electrification, are providing many new challenges and opportunities. We are actively involved in research into not just new drivetrain systems, but potential benefits they bring to other aspects of the vehicle.

Greater vehicle stability through torque vectoring of electric drive motors is a field where we are exploiting our expertise in both driving dynamics and electrical and electronic integration. We are developing novel ways to combine new technologies in electric and hybrid vehicles such as simulated paddle-shift systems with regenerative braking and active noise control to give a more fulfilling driving experience and greater efficiency.

The opportunities are countless and it is an exciting time for research and development for creative thinkers like Lotus.



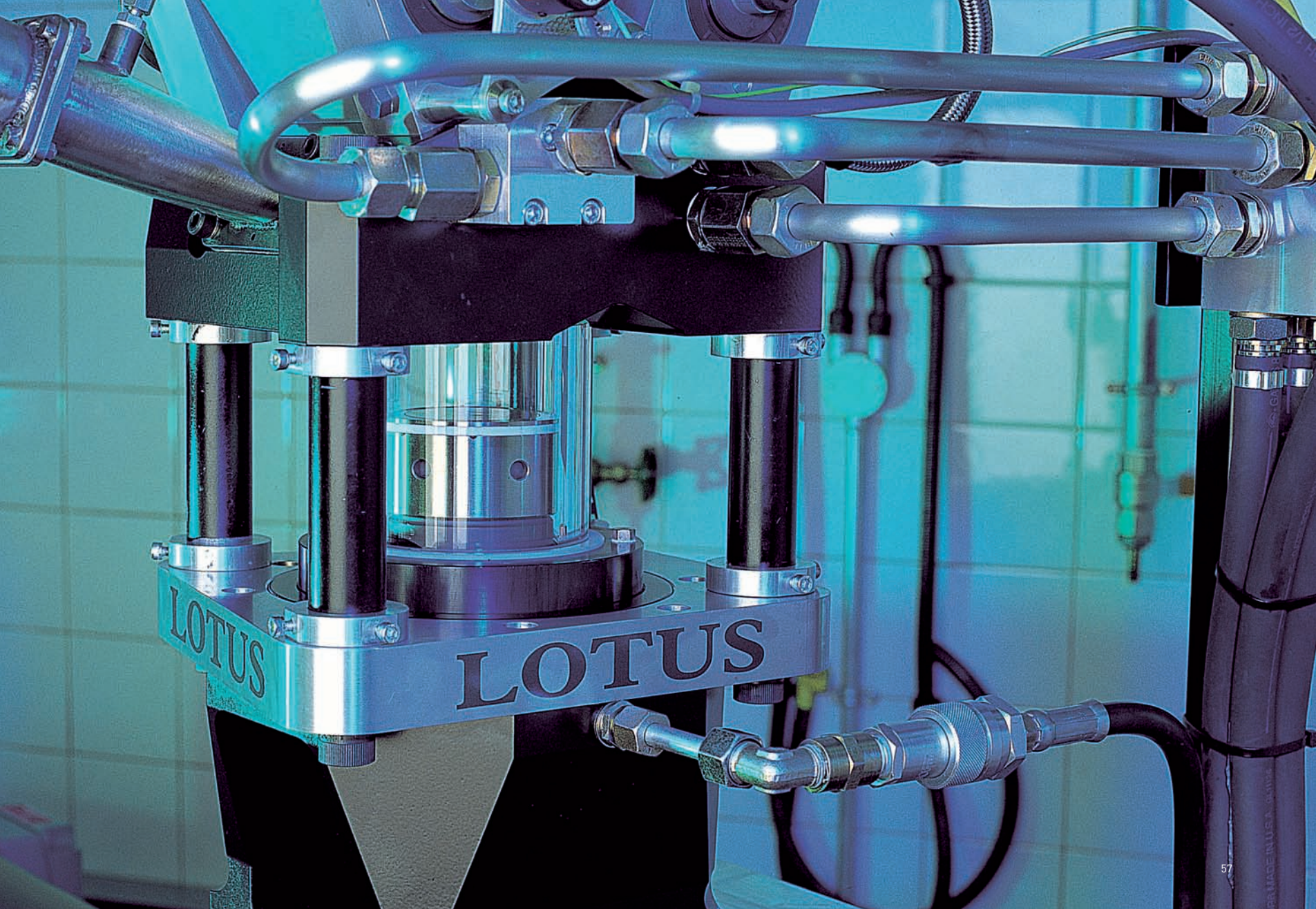



HELPING IN DIFFERENT WAYS

We are happy to share our knowledge with our clients.

We can give full support across the whole development process, be it project definition and target setting, concept design and development, testing and validation or problem solving.

Lotus engineers work within an open, friendly environment and we deliver our expertise in a way that is most relevant to our clients.

Many of our clients recognise that this promotes technology transfer and training for their engineers and ask for our help to develop their expertise. We can do this in many forms from formal

training courses and lectures through to on-the-job training and project leadership.

Formal training can range from on-track driver tuition that hones skills and improves technical understanding, through to process training for supplier development.

During projects, we work closely with the client's engineers and it is a highly effective way to impart our skills and knowledge and to build lasting relationships. Some of the clients who request our help have strong, well-educated teams, but with little real-world project

experience. Here, we can provide key personnel as technical consultants, programme leaders and mentors. Clients reap the benefits of a project successfully completed with Lotus and invaluable experience for their teams.

Ultimately, we pride ourselves on finding the best ways to assist our clients in delivering their objectives.

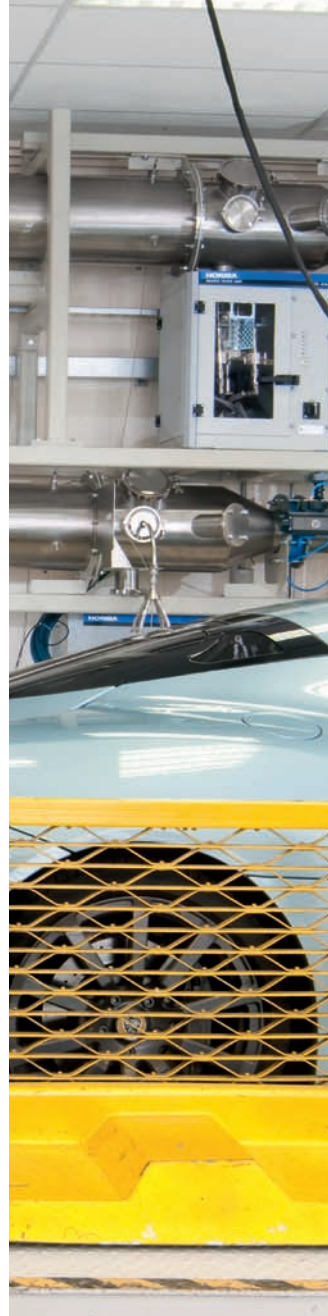



CLOSE TO OUR CLIENTS

As a manufacturer of premium cars, there is a breadth of knowledge and understanding within Lotus. Although we have a strong focus on our four core competencies, inevitably there are occasions when clients want our help in other areas. These can vary from engine and transmission testing to supplier development and sourcing in low-cost countries, and from emissions certification and homologation to project leadership.

We have our own suite of software packages for simulation and analysis of vehicles, engines and vehicle dynamics. Developed by our industry experts and proven on countless projects, these provide users with fast, flexible and powerful tools to assist in many areas of the design process.

We are not limited to the automotive arena and we often apply our engineering and problem-solving capability in other industries.

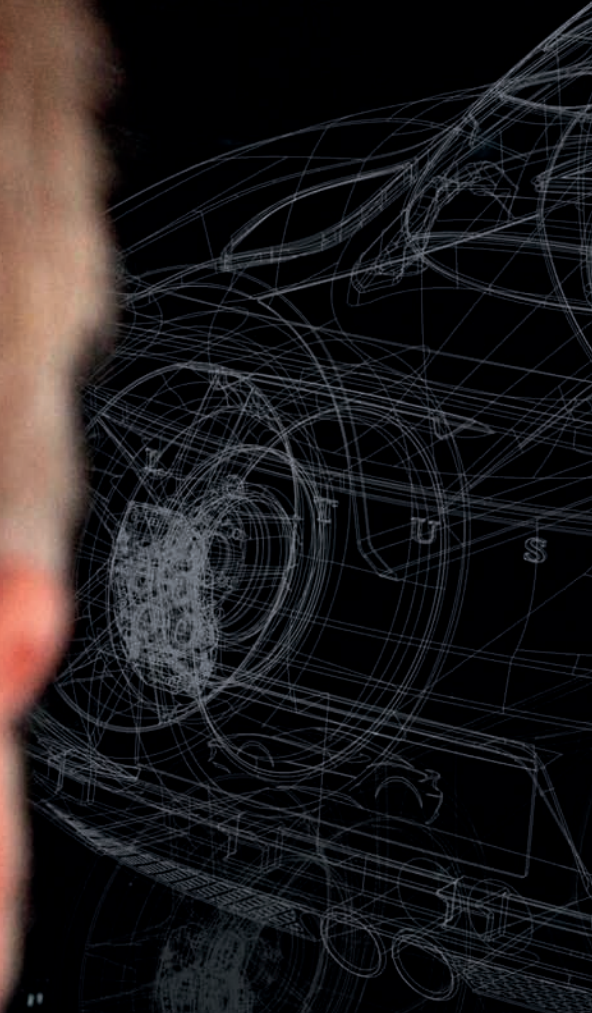



LOTUS ENGINEERING – DRIVING INNOVATION

Underpinning every achievement we have made, every exciting product we have developed and every innovation that we have championed, have been the relentless passion and vision for which Lotus is famous.

We have always created performance through light weight, and have always insisted that cars should be fun to drive and possess real character. These virtues are as important and relevant in today's global automotive industry as they ever were.

With the creation of a new generation of our own cars marking the next exciting chapter for Lotus Engineering, we remain uniquely placed to support the industry in addressing and solving the complex challenges of the evolving automotive world.

We relish the challenge.

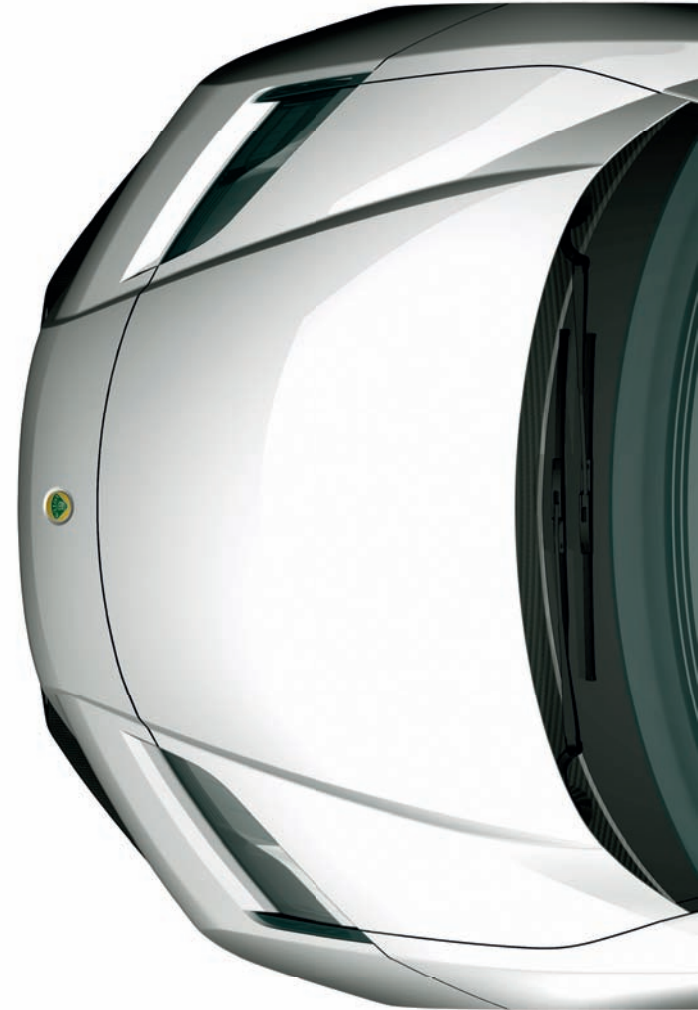

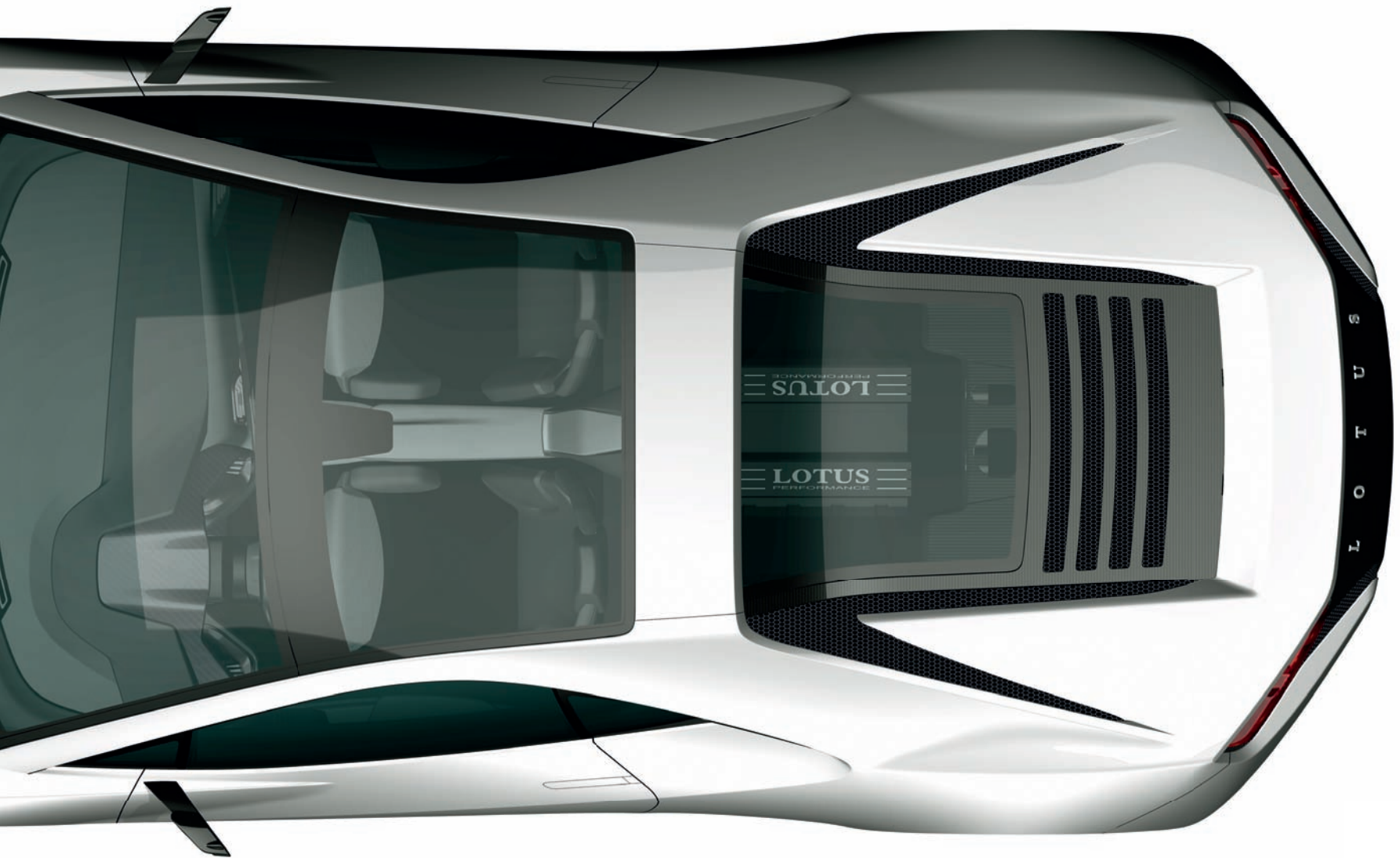

CONTACT US

Lotus Engineering

United Kingdom

Potash Lane, Hethel, Norwich.
NR14 8EZ UNITED KINGDOM

Phone: +44 (0)1953 608423

Fax: +44 (0)1953 608132

eng-uk@lotuscars.com

Lotus Engineering is a trading division of Lotus Cars Limited.
The details in this brochure cannot be reproduced without the
express authorisation of Group Lotus plc.

© Group Lotus plc 2010.

LOTUSCARS.COM/ENGINEERING

Lotus Cars takes its corporate social responsibility seriously. Committed to achieving an FSC 100% claim or FSC Mixed Sources on all of its printed materials.

LOTUSCARS.COM/ENGINEERING

LOTVS05285

